

FELCO 8 - Groen

Snoeischaar - Topprestatie - Ergonomisch

Made in Switzerland by FELCO

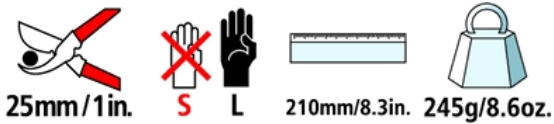

- > **Betrouwbaarheid:** comfortabele, lichte en stevige handgrepen van gesmeed aluminium met levenslange garantie* / bovenmes en geschroefd ondermes in hoogwaardig gehard staal / duidelijke en nauwkeurige snede / alle onderdelen kunnen worden vervangen
- > **Doeltreffendheid:** gemakkelijke en duurzame instelling van de snede / draadsnijder / saggoot
- > **Ergonomie:** bescherming van de hand en van de pols en optimalisatie van de krachten dankzij de ideale vorm van de handgrepen, de gebogen kop en de stootblokjes-schokdemper / antislip-bekleding

AANBEVOLEN VOOR

Onze aanbeveling (★ = Aanbevolen, ★★ = Sterk aanbevolen, ★★★ = De beste keuze)

Wijnbouw	★★★
Fruitteelt	★★★
Tuinbouw	★★★
Parken en tuinen	★★★
Boomkwekerij	★★★
Kleine hand	★★★
Middelgrote hand	★★★
Grote hand	★★★
Rechtshandig	★★★
Linkshandig	★★★

DE BESTE KENMERKEN



Draadsnijder

De messen hebben een inkeping waarmee u dun ijzerdraad kunt knippen, zonder het snijvlak te beschadigen.



Sapgoot

De sapgoot voorkomt dat het blad blijft kleven bij het snijden van "sappig" hout. De goot bespaart tijd en vereenvoudigt het snoeien, omdat sap en afval na iedere knip worden afgevoerd.



Precisie instelling

FELCO's precisie instellingssysteem garandeert een optimale afstelling van de snijkop gedurende de gehele levensduur van het gereedschap. Het garandeert een zuivere en precieze snede.



Systeem van schokbestendigheid

Het kussen en de schokdemper verzachten de impact aan het einde van de knipbeweging. De hand en de pols worden tevens beschermd.



Handgrepen van gesmeed aluminium.

Lichtgewicht, sterk en stevig dankzij speciale aluminium legering en geavanceerde precisie-gesmede methoden. Materiaal met een levenslange garantie*.



Gehoekte snijkop

Om problemen met de spieren en beenderen te beperken en om het gebruiksgemak te verhogen, is de snijbek gebogen (papegaaibek).

ACCESSOIRES



FELCO 902
Slijpgereedschap
Slijpsteen



FELCO 903
Slijpgereedschap
Slijpsteen



FELCO 910
Holster
Van leder - Met sleuf en clip



FELCO 912
Holster
Van leder - Met clip











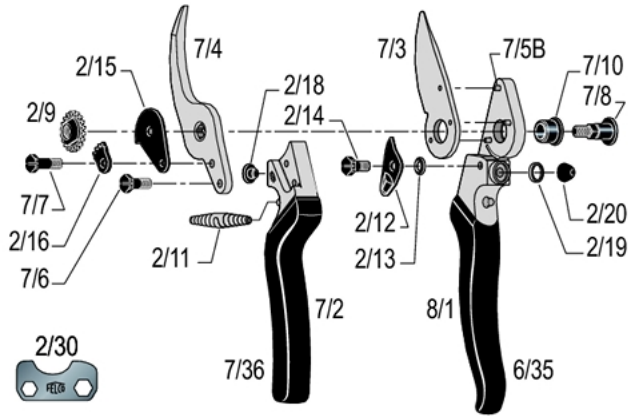









FELCO 980
Onderhoudsproducten
Spray

































FELCO 990
Onderhoudsproducten
Vet

RESERVEONDERDELEN



FELCO	REF.	Omschrijving	Samenstelling	Streepjescode UCC
	2/30	Stelsleutel	1x 2/30	 7 83929 40163 8
	2/92B	Set	1x 2/14 + 1x 2/12B + 2x 2/13	 7 83929 40392 2
	7/3	Bovenmes	1x 7/3	 7 83929 40004 4
	7/3-1	Bovenmes	1x 7/3 1x 2/11 1x 2/30	 7 83929 40418 9
	7/4	Ondermes met schroef	1x 7/4 + 1x 7/6	 7 83929 40012 9
	7/90	Set	1x 7/7 + 1x 2/16 + 1x 2/9 + 1x 7/8	 7 83929 40017 4
	2/91	Set	2x 2/11	 7 83929 40018 1
	2/92	Set	1x 2/15 + 1x 2/18 + 1x 2/14 + 1x 2/12 + 1x 2/13 + 1x 2/20	 7 83929 40020 4
	2/93	Set	4x 2/18 + 6x 2/20	 7 83929 40021 1

	7/94	Set	1x 2/9 + 1x7/8	 7 83929 40028 0
	8/1	Handgreep zonder bovenmes	1x 8/1 + 3x 7/5B + 1x 2/19 + 1x 2/20 + 1x 7/10 + 1x 2/13 + 1x 2/12 + 1x 2/14 + 1x 6/35	 7 83929 40282 6
	7/2	Handgreep zonder ondermes	1x 7/2 + 1x 2/18 + 1x 7/36	 7 83929 40236 9
	6/35	Omhulsel voor bovenmeshandgreep	1x 6/35	 7 83929 40219 2
	7/36	Omhulsel voor ondermes / aanbeeldhandgreep	1x 7/36	 7 83929 40239 0
	7/5B	Klinknagel voor bovenmes	1x 7/5B	 7 83929 40240 6
	7/6	Schroef voor ondermes	1x 7/6	 7 83929 40241 3
	7/8	Bout	1x 7/8	 7 83929 40243 7
	2/9	Getande moer	1x 2/9	 7 83929 40169 0
	7/10	Lagerbus	1x 7/10	 7 83929 40235 2
	2/11	Veer	1x 2/11	 7 83929 40152 2
	2/12	Sluitwervel	1x 2/12	 7 83929 40153 9
	2/13	Veerring	1x 2/13	 7 83929 40154 6
	2/14	Schroef voor sluitwervel	1x 2/14	 7 83929 40155 3
	2/15	Basisplaatje	1x 2/15	 7 83929 40156 0

	2/16	Getande sektor	1x 2/16	 7 83929 40157 7
	7/7	Schroefbout voor getande sektor	1x 7/7	 7 83929 40242 0
	2/18	Stootblokje	1x 2/18	 7 83929 40159 1
	2/19	Tussenring	1x 2/19	 7 83929 40160 7
	2/20	Stootdemper	1x 2/20	 7 83929 40162 1

ZORG



Schoonmaken

Het is aangeraden uw gereedschap na elk gebruik schoon te maken. Vooral als uw gereedschap erg vuil is of kan roesten na blootstelling aan vocht, moet u het onmiddellijk schoonmaken.



Oliën

Na een schoonmaakbeurt is het aangeraden het gereedschap te oliën om het te beschermen tegen roest. Met olie kan u ook vastgelopen gereedschap weer losmaken.



Slijpen

Het is aangeraden uw gereedschap minstens eenmaal per dag te slijpen, maar als u voelt dat uw gereedschap minder goed snijdt, slijp het dan onmiddellijk!



Demonteren

Het is aangeraden uw gereedschap regelmatig te demonteren, maar zeker als u voelt dat het stroever wordt.

VERVANGING ONDERDELEN



Het bovenmes vervangen

Wanneer het boven- en ondermes niet meer kruisen of als het bovenmes te veel beschadigd is, is het aangeraden het te vervangen.

Regel de speling van het boven- en ondermes door de spanning van de moer aan te passen. Het bovenmes moet het ondermes op 2/3 van de lengte raken.



Het ondermes vervangen

Wanneer het boven- en ondermes niet meer kruisen of als het ondermes te veel beschadigd is, is het aangeraden het te vervangen.



De schokdemper vervangen

Wanneer het gereedschap te hard sluit bij het snoeien en het stootblokje nog in goede staat is, is het aangeraden de schokdemper te vervangen.



Het stootblokje vervangen

Wanneer het gereedschap te hard sluit bij het snoeien en de schokdemper nog in goede staat is, is het aangeraden het stootblokje te vervangen.



De sluitwervel vervangen

Wanneer de sluitwervel beschadigd is en niet meer kan worden gebruikt, zelfs als u de schroef aanspant, moet u hem vervangen.



De omhulsel van de handgrepen vervangen

Wanneer de bekledingen te veel beschadigd zijn, kunt u ze vervangen.

Houd de bekledingen 2 minuten in kokend water – aanbevolen lijm: Loctite 415.