

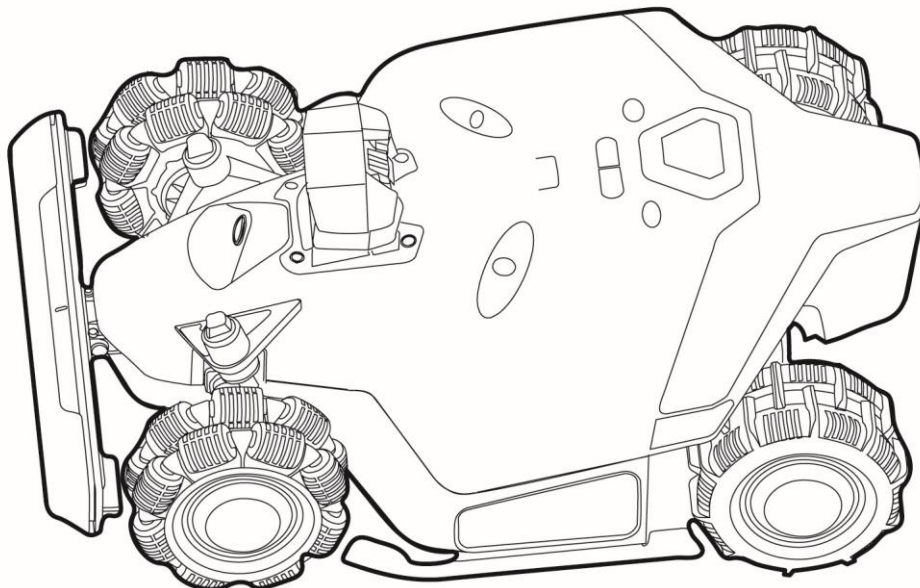

Original Instructions



LUBA 2 AWD SERIES

-User Manual-

V1.0 2024.01

Thank you for choosing Mammotion as your garden care lawn mower. This user manual will help you learn and operate Mammotion Luba, a 4-wheel-drive and perimeter-free lawn mower, to cut grass and maintain your lawn.

This manual is copyrighted by Mammotion Tech company. Without the written permission of the company, any unit or individual shall not copy, modify, reproduce, transcribe or transmit in any way or for any reason. This manual is subject to change without notice at any time.

Revision Log

Date	Version	Description
2024.01	V1.0	Initial version

CONTENTS

1	Safety Instructions	- 1 -
1.1	General Safety Instructions	- 1 -
1.2	Safety Instructions for Installation.....	- 2 -
1.3	Safety Instructions for Operation.....	- 3 -
1.4	Battery Safety.....	- 4 -
1.5	Residual Risks.....	- 4 -
2	Introduction	- 5 -
2.1	About Mammotion Luba.....	- 5 -
2.2	In the Box.....	- 9 -
2.3	Symbols on the Product	- 12 -
2.4	Product Overview.....	- 14 -
3	Installation.....	- 16 -
3.1	Preparation	- 16 -
3.2	Choosing a Location for RTK Reference Station.....	- 16 -
3.3	Choosing a Location for Charging Station.....	- 18 -
3.4	Installing.....	- 20 -
4	Operation.....	- 28 -
4.1	Preparation	- 28 -
4.2	Download Mammotion App.....	- 28 -
4.3	Mammotion Account Signup and Login.....	- 29 -
4.4	Add Luba.....	- 32 -

4.5	Map Page Introduction	- 33 -
5	Product Specifications	- 60 -
5.1	Technical Specifications.....	- 60 -
5.2	LED Indicator Codes.....	- 63 -
5.3	Fault Codes.....	- 65 -
6	Warranty	- 67 -
7	Compliance.....	- 70 -

1 Safety Instructions

1.1 General Safety Instructions

- Carefully read and understand the user manual before using the product.
- Only use the equipment recommended by Mammotion Tech with the product. Any other usage is incorrect.
- Never allow children, persons with reduced physical, sensory or mental capabilities or lack of experience and knowledge or people unfamiliar with these instructions to use the machine, local restrictions may restrict the age of the operator.
- Do not allow children to be in vicinity or play with the machine when it is operating.
- Do not use the product in areas where people are unaware of its presence.
- When manually operating the product with the Mammotion App, do not run. Always walk, watch your steps on slopes, and maintain balance at all times.
- Avoid touching moving hazardous parts, such as the blade disc, until it has completely stopped.
- Avoid using the product when there are people, especially children or animals, in the work area.
- If operating the product in public areas, place warning signs around the work area with the following text: "Warning! Automatic lawn mower! Keep away from the machine! Supervise children!"
- Wear sturdy footwear and long trousers when operating the product.
- To prevent damage to the product and accidents involving vehicles and individuals, do not set work areas or transport paths across public pathways.
- Do not touch moving hazardous parts, such as the blade disc, before it has come to a

complete stop.

- Seek medical aid in case of injury or accidents.
- Set the product to **OFF** and remove the key before clearing blockages, performing maintenance, or examining the product. If the product vibrates abnormally, inspect it for damage before restarting. Do not use the product if any parts are defective.
- Do not connect or touch a damaged cable until it is disconnected from the power outlet. If the cable becomes damaged during operation, disconnect the plug from the power outlet. A worn or damaged cable increases the risk of electrical shock and should be replaced by service personnel.
- Do not install the main cable in areas where the product will cut. Follow the instructions provided for cable installation.
- Only use the charging station included in the package to charge the product. Incorrect use may result in electric shock, overheating, or corrosive liquid leakage from the battery. In case of electrolyte leakage, flush with water/neutralizing agent and seek medical aid if the corrosive liquid comes into contact with your eyes.
- When connecting the main cable to the power outlet, use a residual-current device (RCD) with a maximum tripping current of 30 mA.
- Only use original batteries recommended by Mammotion Tech. The safety of the product cannot be guaranteed with non-original batteries. Do not use non-rechargeable batteries.
- Keep extension cords away from moving hazardous parts to avoid damage to the cords which can lead to contact with live parts.
- The illustrations used in this document are for reference only. Please refer to the actual products.

1.2 Safety Instructions for Installation

- Avoid installing the charging station in areas where people may trip over it.
- Do not install the charging station in areas where there is a risk of standing water.

- Do not install the charging station, including any accessories, within 60 cm/24 in of any combustible material. Malfunctioning or overheating of the charging station and power supply can pose a fire hazard.
- For users in the USA/Canada: If installing the power supply outdoors, there is a risk of electric shock. Only install it in a covered Class A GFCI receptacle (RCD) with a weatherproof enclosure, ensuring that the attachment plug cap is inserted or removed.

1.3 Safety Instructions for Operation

- Keep your hands and feet away from the rotating blades. Do not place your hands or feet near or below the product when it is turned on.
- Do not lift or move the product when it is turned on.
- Use the park mode or set the product to **OFF** when there are people, especially children or animals, in the work area.
- Ensure that there are no objects such as stones, branches, tools, or toys on the lawn. Otherwise, the blades may be damaged when they come into contact with an object.
- Do not put objects on top of the product, charging station or RTK reference station.
- Do not use the product if the **STOP** button is not functioning.
- Avoid collisions between the product and people or animals. If a person or animal comes in the path of the product, stop it immediately.
- Always set the product to **OFF** when it is not in operation.
- Do not use the product simultaneously with a pop-up sprinkler. Utilize the Schedule function to ensure that the product and pop-up sprinkler do not operate at the same time.
- Avoid placing a connection channel where pop-up sprinklers are installed.
- Do not operate the product in the presence of standing water in the work area, such as during heavy rain or water pooling.

1.4 Battery Safety

Lithium-ion batteries can explode or cause a fire if disassembled, short-circuited, exposed to water, fire, or high temperatures. Handle them with care, do not dismantle or open the battery, and avoid any form of electrical/mechanical abuse. Store them away from direct sunlight.

- Only use the battery charger and power supply provided by the Manufacturer. The use of an inappropriate charger and power supply can cause electric shocks and / or overheating.
- DO NOT ATTEMPT TO REPAIR OR MODIFY BATTERIES! Repair attempts may result in severe personal injury, due to explosion or electrical shock. If a leak develops, released electrolytes are corrosive and toxic.
- This appliance contains batteries that are only replaceable by skilled persons.

1.5 Residual Risks

To avoid injuries, wear protective gloves when replacing the blades.

2 Introduction

2.1 About Mammotion Luba

The Luba 2 AWD series, also known as Luba, is a 4-wheel-drive robotic lawnmower with a suspension system that provides better grip through its spring. Luba is equipped with RTK GNSS navigation and virtual-mapping systems, which allow users to customize their mowing tasks by defining different mowing areas and schedules in the Mammotion app. Additionally, Luba offers an IOT service and a rain sensor, providing a hands-free and picture-perfect lawn maintenance experience.

The Luba 2 AWD is newly equipped with a vision module, 4G module, Alexa voice control, anti-theft, etc., which are explained in the following sections.

The Luba 2 AWD series includes two types of models:

- Standard version (Model: 1000, 3000, 5000, and 10000) — provides cutting height of 30-70 mm/1.2-2.7 inches.
- H version (Model: 1000H, 3000H, 5000H, and 10000H) — provides cutting height of 60-100 mm/2.4-4 inches.

2.1.1 About vision module

Luba is equipped with a vision module that provides vision positioning, vision-based obstacle avoidance, and video data transmission.

- **Vision positioning** helps to guarantee positioning accuracy when RTK positioning fails due to poor satellite signals.
- **Vision-based obstacle avoidance** identifies obstacles in the front.
- **Video data transmission** can be used for monitoring as a security camera or as an FPV (First Person View) camera.

2.1.2 About positioning

Luba is equipped with a RTK (real-time kinematic) navigation system, a multi-sensor integrated navigation system, and a vision positioning system, which provide more accurate positioning data.

RTK positioning

RTK is a differential GNSS positioning technology that greatly enhances positioning accuracy to approximately 5 cm/2 in. Luba accesses four global navigation systems (GPS, GLONASS, BeiDou, and Galileo) and incorporates supplementary sensors, thus, providing nearly 100 times improved accuracy than conventional GPS systems.

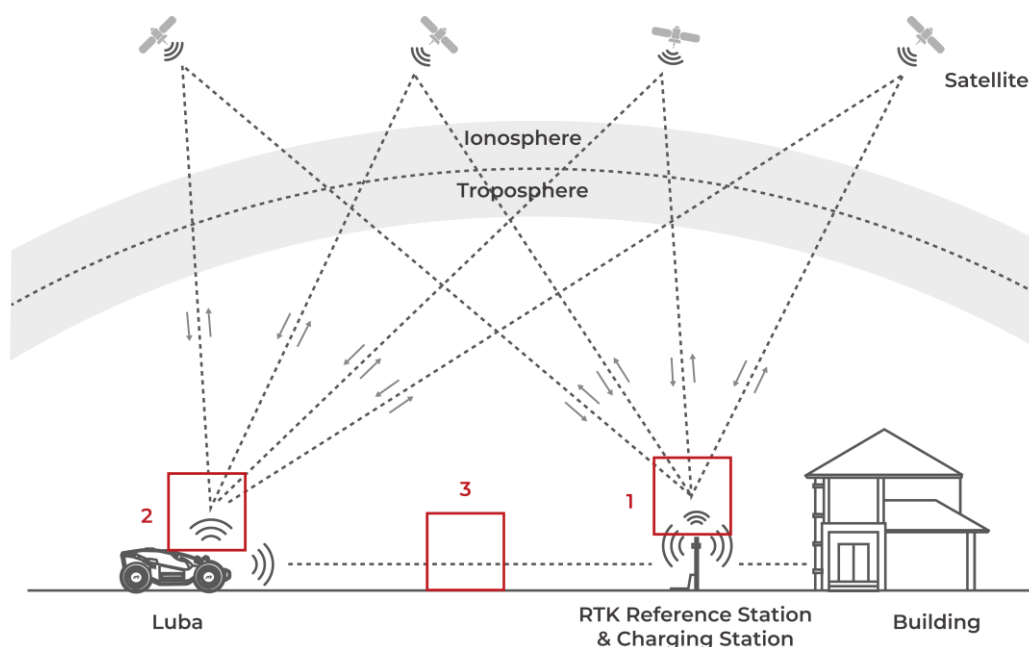

1. To perform its work, the RTK reference station receives satellite signals, requiring an obstruction-free environment and open-sky view.
2. Luba operates similarly, requiring an open sky view to receive satellite signals.
3. Data transmission from the RTK reference station to Luba is possible. This does not imply that there must constantly be an unobstructed view from every point on your lawn to the RTK reference station. As long as the transmission path is not completely blocked, the data can be transmitted via radio.

Vision positioning

Luba primarily uses RTK positioning to locate itself. However, in situations where satellite signals are obstructed by obstacles such as eaves or trees during mapping and mowing, Luba can still operate effectively using vision positioning as long as there is sufficient brightness.

2.1.3 About obstacles avoidance

Luba supports both visual and ultrasonic obstacle avoidance. The vision-based system can identify obstacles and respond accordingly, while the ultrasonic system is used to detect obstacles in low-light environments where visual identification is difficult.

2.1.4 About connectivity

Luba can access the Internet through Wi-Fi and 4G cellular data.

2.1.5 About Alexa voice control

Luba is compatible with Alexa voice control. You can easily start or stop mowing or recharging by using simple voice commands. For instance, say 'Alexa, start charging' to initiate the charging process.

To link your Alexa account

1. Go to **Account** page in the Mammotion app.
2. Select **Alexa**.
3. Follow the onscreen instructions to finish the setup. Afterward, you can activate Luba by speaking to her.

2.1.6 About Auto-recharge

Auto-recharge allows Luba to automatically return to charge when the battery is lower than 15%.

2.1.7 About anti-theft system

Luba has an anti-theft system to prevent unauthorized removal.

- The alarm is triggered when Luba is lifted.
- Users can track Luba's location through the Mammotion app, as long as it is online.
- Additionally, Luba's structure allows for an AirTag to be attached to track its location.

2.2 In the Box

2.2.1 Luba installation kit

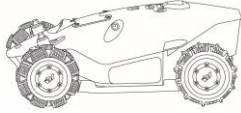

Luba x1



Luba Bumper x1



Screw x4 (2 pcs for spare use)



Key x2



Vision Module x1



Screw x8 (4 pcs for spare use)

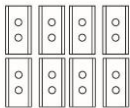

Replacement Blades x8 (for spare use)

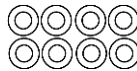

Washer x8 (for spare use)



Screw x8 (for spare use)

2.2.2 Charging station installation kit

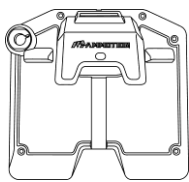

Charging Station x1

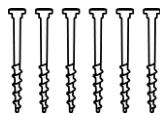

Screw x6



Gasket x2

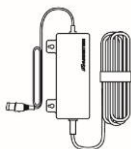

Charging Station Power Supply x1

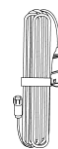

Charging Station Extension Cable (10M) x1

2.2.3 RTK installation kit



RTK Reference Station x1



Radio Antenna x1

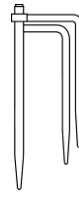

Trident Ground Stake x1

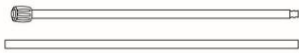

Mounting Pole x2

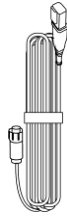

RTK Reference Station
Extension Cable (10M) x1

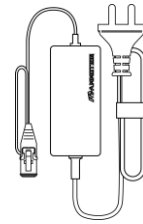

RTK Reference Station
Power Supply x1

2.2.4 Tool kit



Allen Key 8mm x1



Allen Key x1

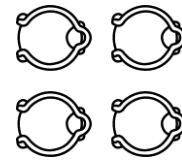

Cord Tie x4

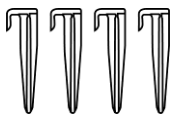

Stake x4



SIM-eject Tool x1

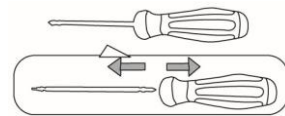

Screwdriver (Phillips
bit+2.5mm hex bit) x1

2.2.5 Other accessories (optional)

The following accessories are sold separately.

RTK reference station wall mount kit

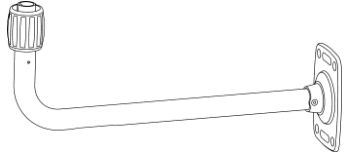

RTK Wall Mount x1

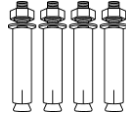

M8x50 Expansion Bolt x4

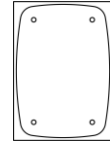

Drilling Template x1











Luba garage





Luba Garage x1

2.3 Symbols on the Product

These symbols can be found on the product. Study them carefully.

Symbol	Description
	Warning.
	Read user manual before operating the product.
	This product complies with the applicable EU Directives.
	This product complies with the applicable UK Directives.
Made in China	This product is manufactured in China.
	It is not permitted to dispose this product as normal household waste. Ensure that the product is recycled in accordance with local legal requirements.
	This item can be recycled.
	Keep the pack of this product dry.
	The pack of this product should not be covered.
	Prohibit flipping.
	This product is fragile.
	The pack of this product / the product should not be tread.

Symbol	Description
	Class III appliance.
	Keep hands or feet away from movable blades.
	Do not ride on the product.
	Keep a safe distance from your product when operating.
	WARNING: Do not touch rotating blade.
	WARNING: Read the user instructions before operating the product.
	WARNING: Danger of projections of objects against the body. Keep an adequate safe distance from the machine while it is running.
	WARNING: Do not put hands and feet near or under the opening of the cutting means. Remove the disabling device before operating on the machine or before lifting it.
	WARNING: Do not ride on the product. Never put your hands or feet close to or under the product.

2.4 Product Overview

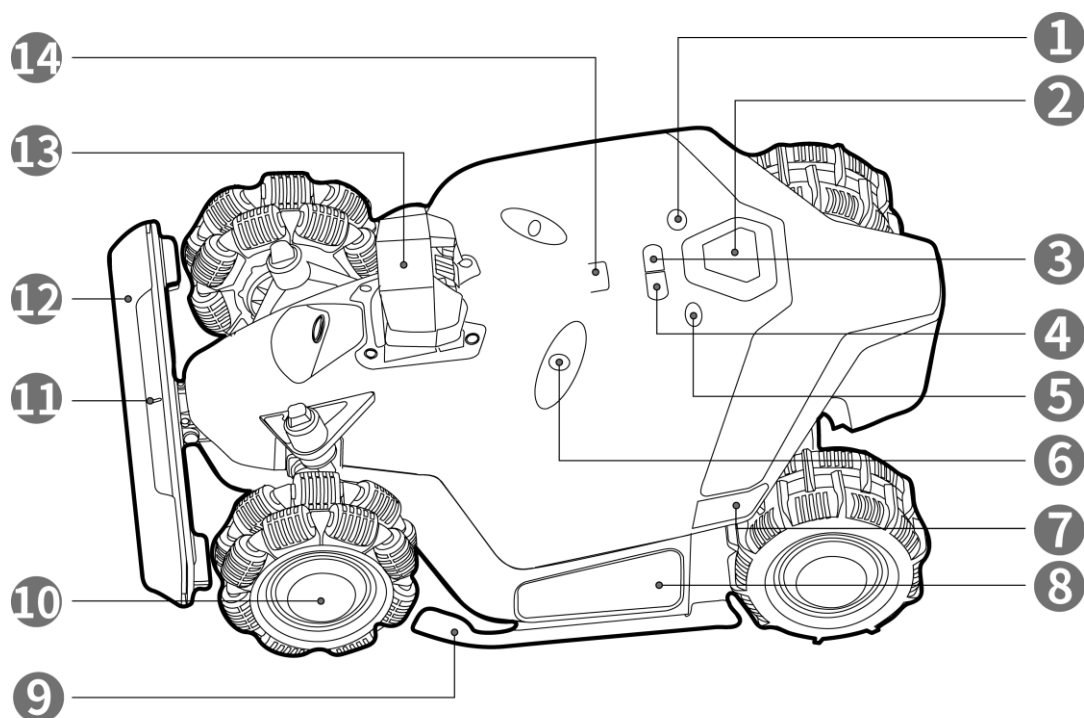



Figure 2-1 Front View of Luba

- | | |
|--|---|
| 1. Start Button | 2. Emergency Stop Button |
| 3. Auto-return Button — press to call back Luba ¹ | 4. Grass Button — press to continue the task ² |
| 5. Power Button — long press to turn on/off Luba | 6. Ultrasonic Sensor |
| 7. Side Indicator | 8. Cushion |
| 9. Protection Bracket | 10. Omni Wheel |
| 11. Front Indicator | 12. Bumper |
| 13. Vision Module | 14. Rain Sensor |

NOTE

1. To come back to charging station: press Auto-return 🏠, then press Start .
 2. To continue task: press Grass 🌿, then press Start .
-

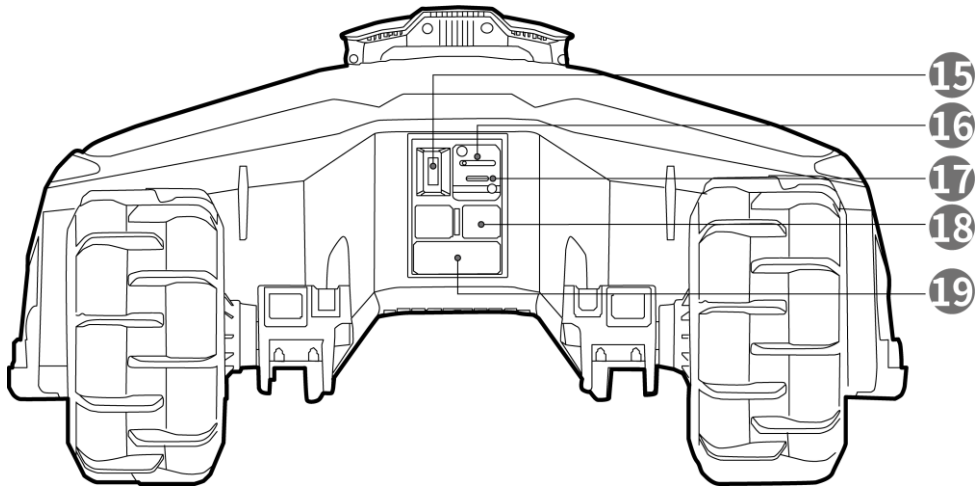

Figure 2-2 Rear View of Luba

- 15. Key hole
- 16. SIM card tray
- 17. USB port — for troubleshooting and debugging
- 18. Charging port
- 19. Infrared receiver

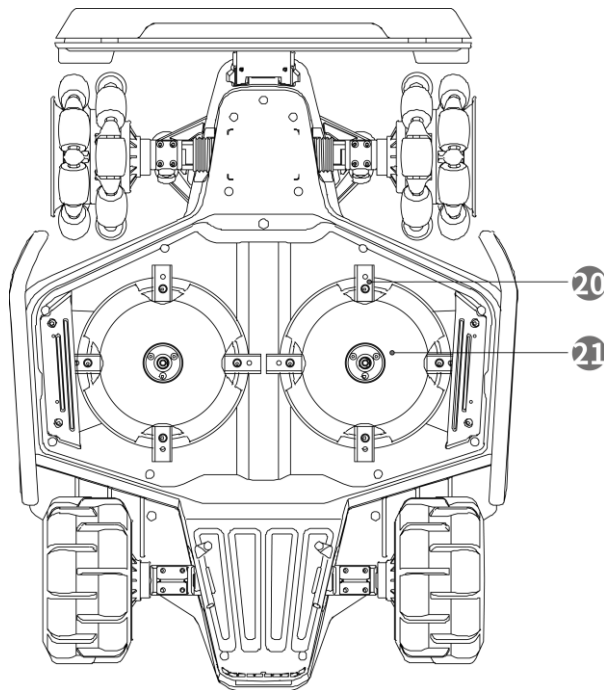

Figure 2-3 Bottom View of Luba

- 20. Cutting blade
- 21. Cutting disk

3 Installation

3.1 Preparation

- Read and understand the safety instructions prior to installation.
- Use original parts and installation materials.
- Sketch your lawn and mark up obstacles. This will make it easier to examine where to place the charging station and RTK reference station, and to set the virtual boundaries.

3.2 Choosing a Location for RTK Reference Station

To optimize the performance of the RTK system, the RTK reference station must be in an open area to receive satellite signals. You can install the RTK reference station on flat, open ground or on an unobstructed wall or roof. In general, if your lawn is L-shaped, you can place the RTK reference station on a wall or roof or on the ground; if your lawn is O-shaped or U-shaped, or if you have multiple lawns, we recommend that you place the RTK reference station on a wall or roof.

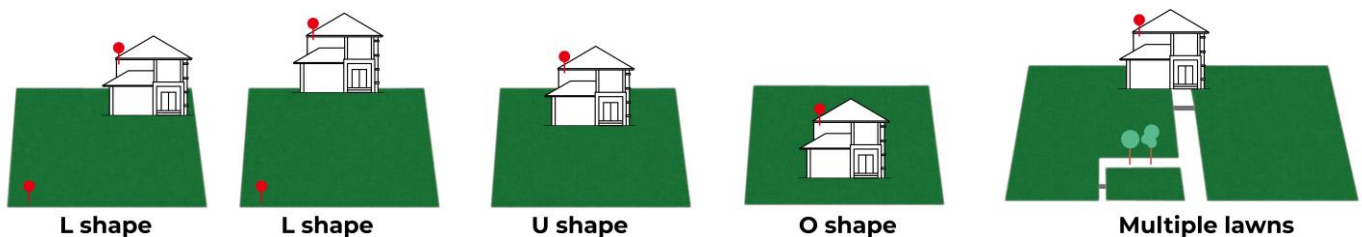

The location requirements are as follows:

- The RTK reference station should be oriented vertically, as shown below:



- Place the RTK reference station on a flat, open ground or on an unobstructed wall or roof. Make sure there are no roofs or trees that may obstruct the satellite signals.
- DO NOT install the RTK reference station at the corner of an L-shaped building or on a narrow path between two structures or under a tree.

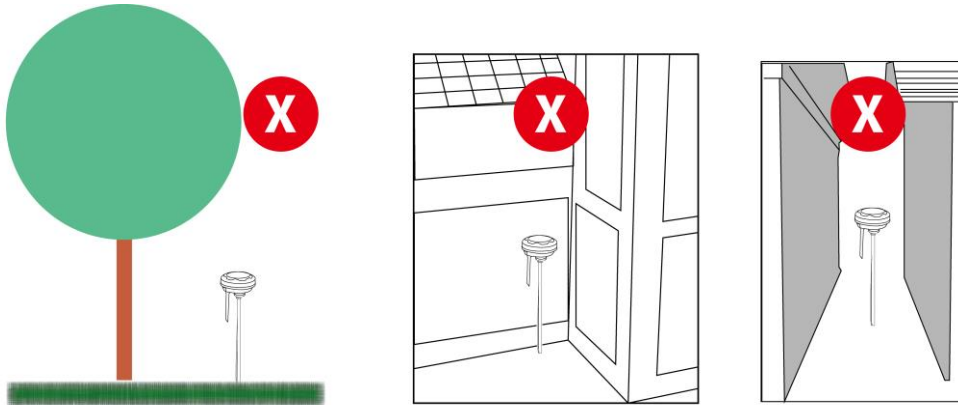

3.3 Choosing a Location for Charging Station

- Place the charging station on a flat ground.
- DO NOT install the charging station at the corner of an L-shaped building or on a narrow path between two structures.
- No obstacles or other items should be between the charging station and the docking point.
- The base plate of the charging station must not be bent or tilted.

Here are some examples to clearly show correct and wrong settings:

- Flat and solid ground
- Short grass

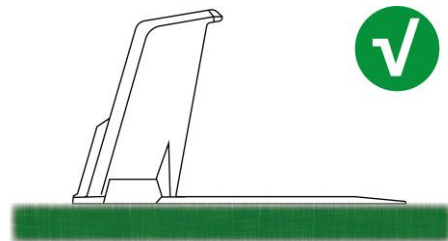

On a slope

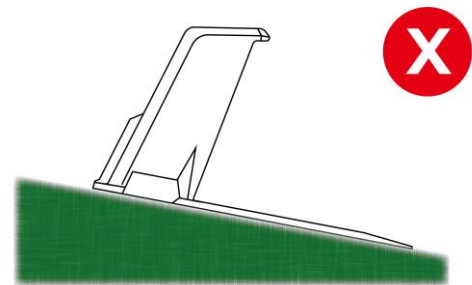

- Ground not flat
- Easy to bend when a heavy object on it, such as Luba.

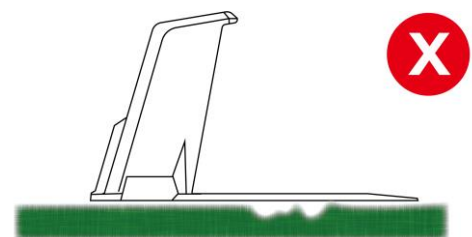

- Thick grass
- Easy to bend when a heavy object on it, such as Luba.

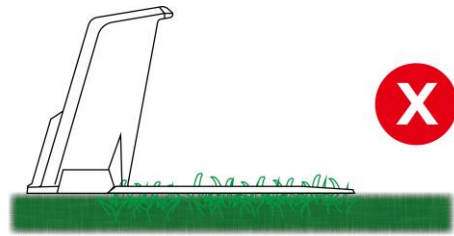

3.4 Installing

3.4.1 RTK reference station installed on a wall/roof (recommended)

1. Choose a suitable installation area at a high place of your house.
2. Stick the drilling template on the wall and drill four holes (10 x 40mm/0.4 x 1.6 in) at the appropriate position.
3. Attach the RTK wall mount on the wall using the four bolts (M8 x 50) and secure the bolts firmly.
4. Fix the radio antenna to the RTK reference station.
5. Route the RTK reference station cable into the wall mount as shown.
6. Attach the RTK reference station to the wall mount.
7. Connect the RTK reference station plug to the RTK reference station extension cable (10 m/33 ft.).

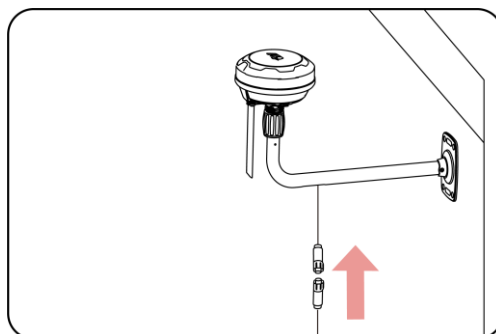
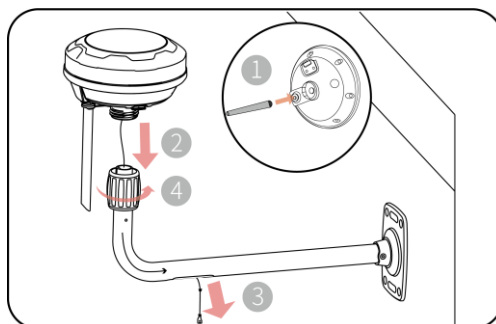
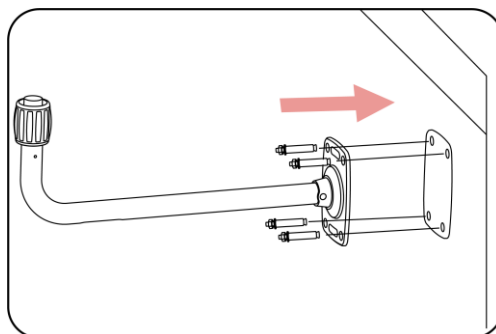
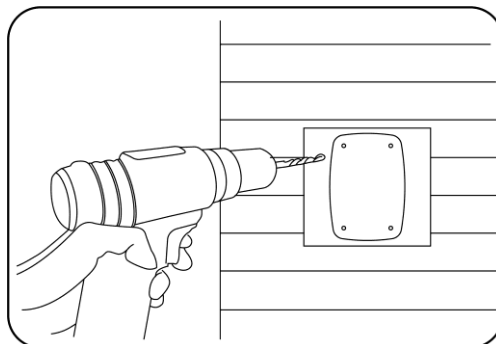

8. Connect the RTK reference station cable (10 m/33 ft.) to the RTK reference station power supply.

9. Plug the power supply into a wall socket.

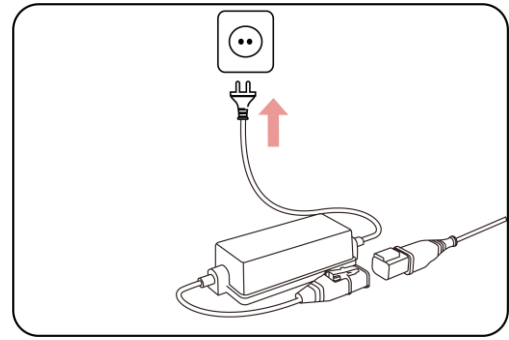

10. Select an open spot to install the charging station.

11. Use the six screws to properly fasten the charging station in the position as shown.

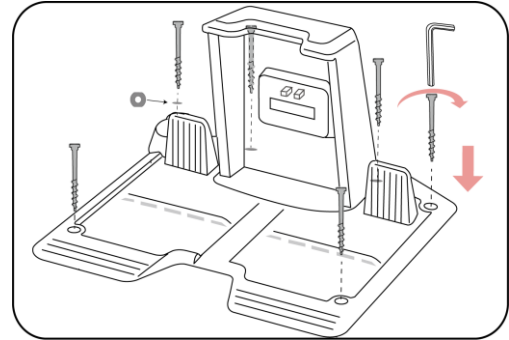

12. Connect the wires as shown in the figure.

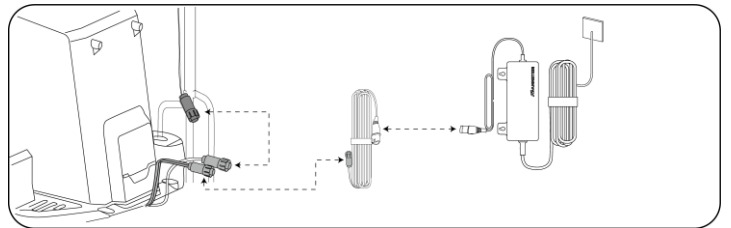

3.4.2 RTK reference station installed on the ground

1. Fix the radio antenna to the RTK reference station.

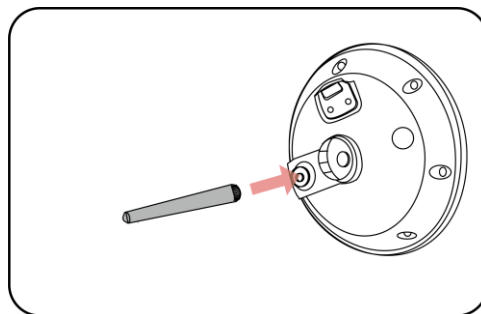

2. Assemble the two mounting poles and the trident ground stake as shown.

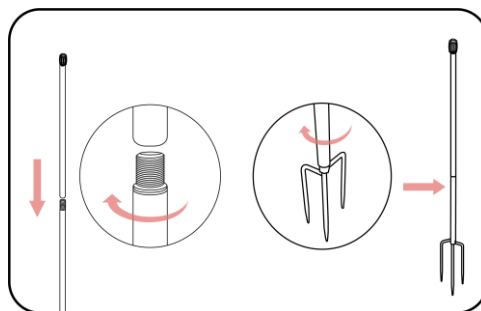

3. Route the RTK reference station cable into the mounting pole as shown.

4. Mount the RTK reference station on the mounting pole.

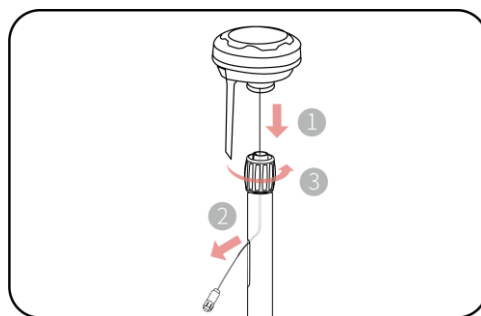

5. Secure the charging station on the flat surface using the five fixing screws. Place a gasket onto the inlet, then insert and fix the trident ground stake as shown in the figure and keep it upright.

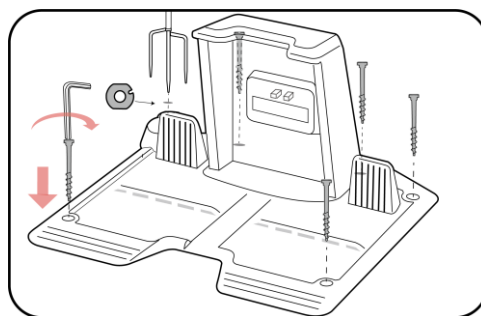

6. Connect the wires as shown in the figure.

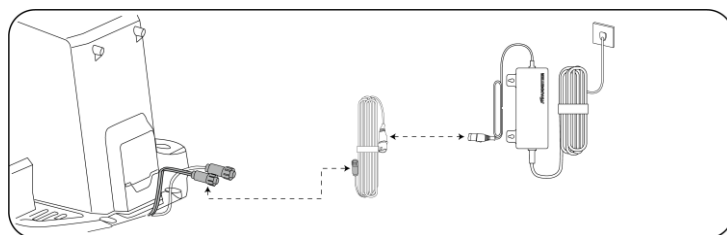

3.4.3 Luba Assembly

Installing the vision module

1. Loosen the four screws using a screwdriver with a 2.5mm hex bit to remove the cover.

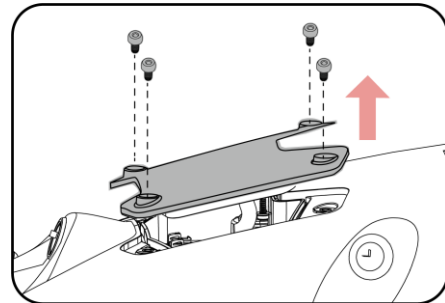

2. Connect the vision module wires (black to black and white to white).

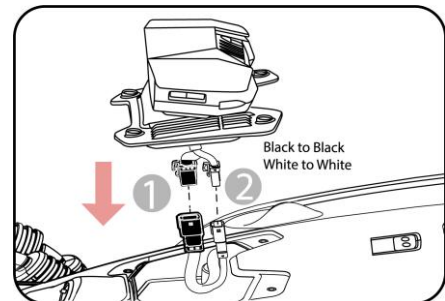

3. Attach the vision module to the Luba using the four screws and tighten them with a 2.5mm hex screwdriver.

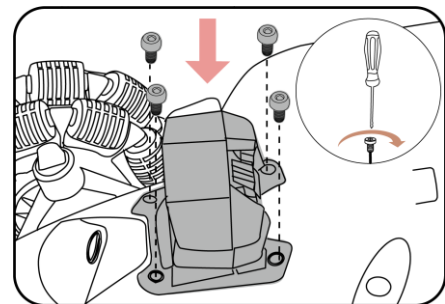

Installing the Luba bumper

1. Gently pull the plug inside the Luba out and connect it to the bumper.

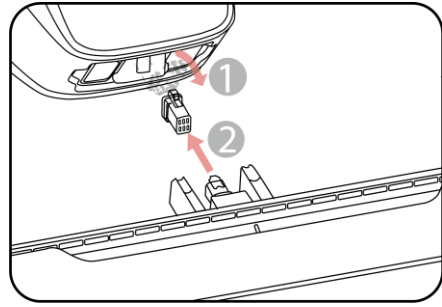

2. Place the bumper into position with the front indicator facing upwards by pressing and holding the buttons.

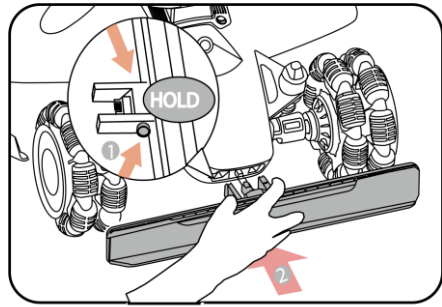

3. Install and tighten the two screws using a 2.5mm hex screwdriver.

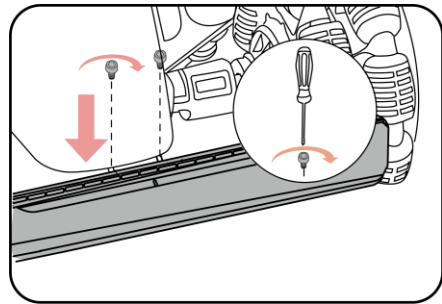

Installing the security key

Insert a key into the rear keyhole.

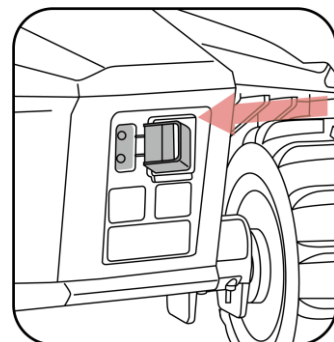

Installing the 4G sim card (optional)

1. Use the Allen key to detach the rear cover.

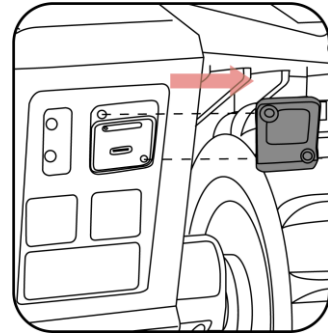

2. Eject the SIM card tray using the SIM-eject tool, install the SIM card, and push the card tray into place.

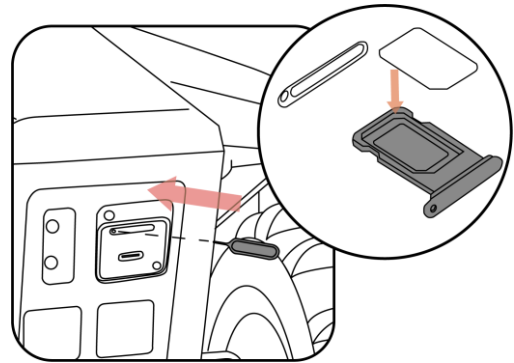

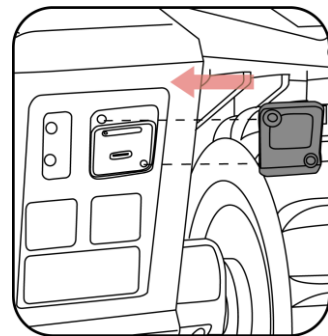

3. Reinstall the rear cover.



3.4.4 Docking Luba

After the charging station and RTK reference station have been properly installed, place Luba on the charging station by:

- Placing or driving Luba about 1.5 m/5 ft. in front of the charging station with the back of Luba facing the charging station. Press the **Power** button  on Luba to turn it on. Then press the **Auto-return** button  and the **Start** button  to return Luba to the charging station.

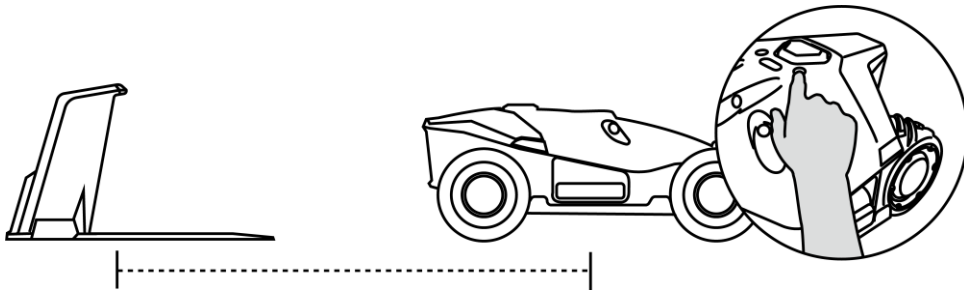

- Move Luba onto the charging station and wait for Luba to power on automatically.

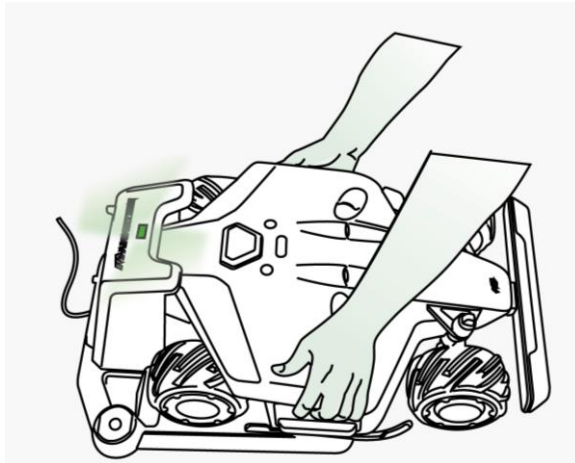

3.4.5 Installing the Luba garage (optional)

Attach the garage to the top of the charging station from front to back and tighten the two screws on the back of the garage to complete the installation.

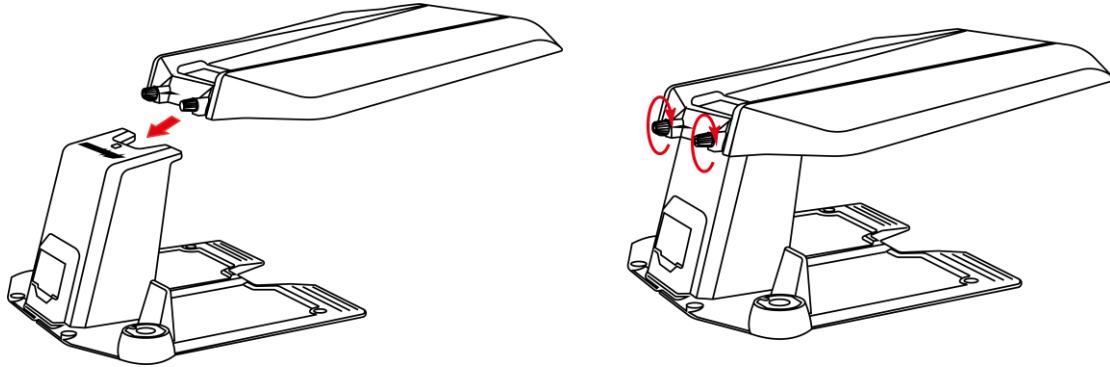

NOTE

- Do not place anything on top of the garage to avoid damage and interference with the vehicle signal.
- The garage can be lifted to a maximum angle of 30°.
- If it snows a lot in your area during the winter, it is recommended to store Luba indoors. If Luba is stored under the garage, clear the snow before starting work. Remove any ice from the shaft before lifting the garage.

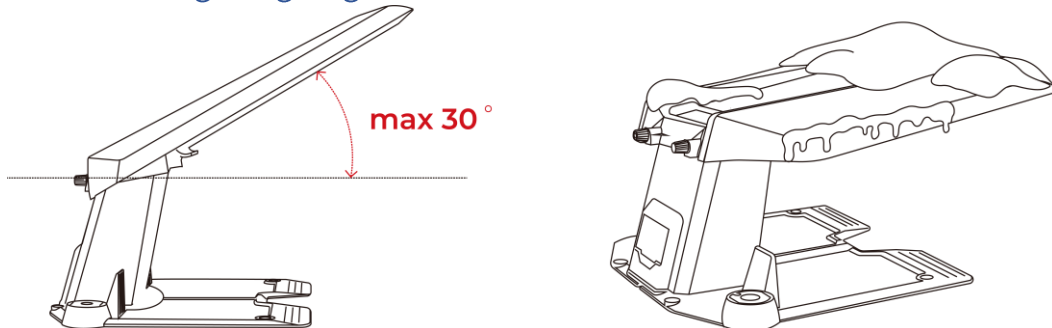

4 Operation

4.1 Preparation

- Read and understand safety instructions before operation.
- The charging station and RTK reference station have been properly installed.
- Ensure Luba has already docked on the charging station. If not, refer to *Docking Luba*.
- Ensure there is a good Wi-Fi or hot spot signal.
- Keep your phone Bluetooth on.

4.2 Download Mammotion App

Luba is designed to work with the Mammotion app, please download the free Mammotion app first. You can scan the QR code below to get it from the Android or Apple app stores, or search for Mammotion in these stores.

Get it on Google Play store



Available on the Apple App Store



4.3 Mammotion Account Signup and Login

4.3.1 To sign up

NOTE

If you already have a Mammotion account, input your account and password to log it in.

After successfully install the Mammotion app in your phone, you are ready to create your account. Follow the below instructions to register one.

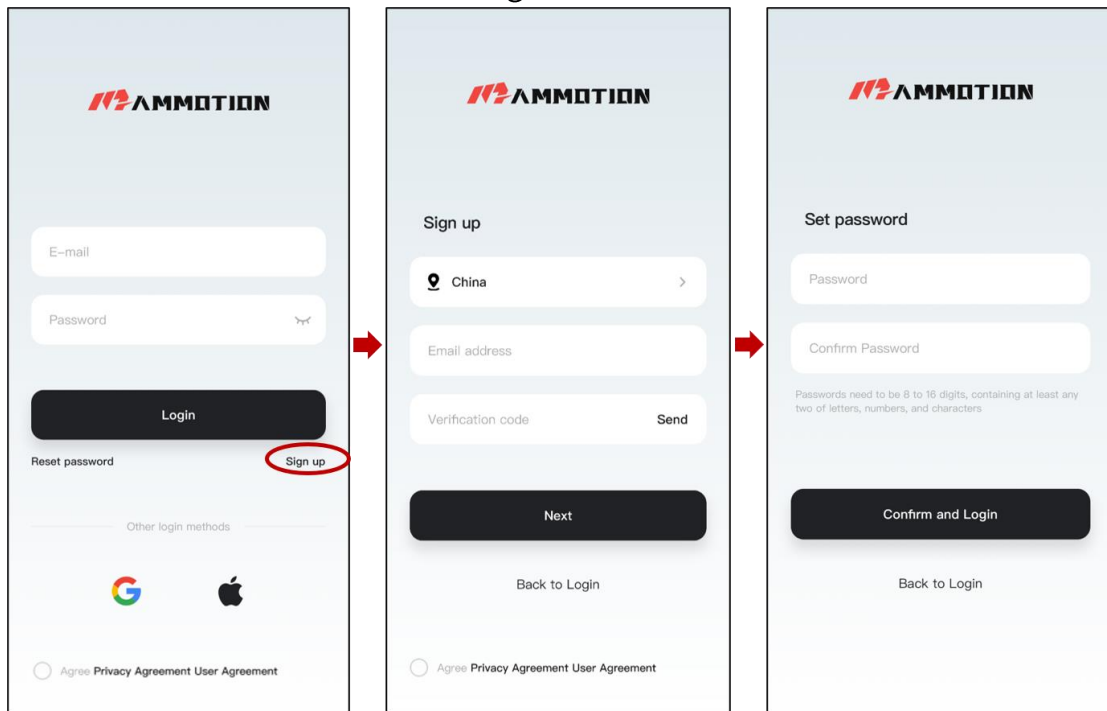

1. Click **Sign up**.
2. Select your country, input your email address.
3. Click **Send**. A verification code will be sent to your email (If you do not receive the code, please check your spam folder or the blacklist of your email).
4. Input the code (The verification code is valid for 10 minutes. If it expires, click **Send** again to get a new one).
5. Check the Privacy Agreement User Agreement and click **Next** to set your password

(Passwords must be 8 to 16 characters with at least two of the following: letters, numbers, and special characters.).

6. Click **Confirm and Login** to finish the signup.

4.3.2 To log in

Log in with a Mammotion account

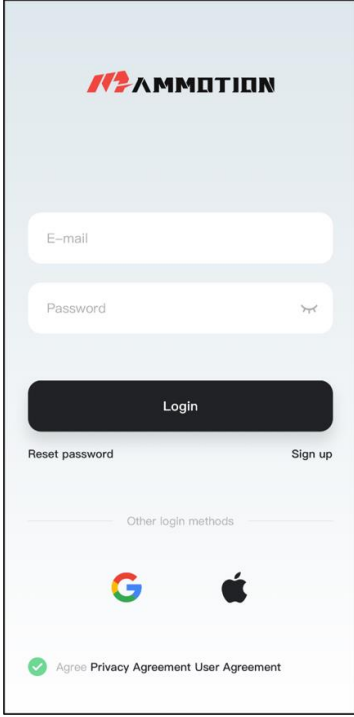

The image shows a mobile login screen for Mammotion. At the top is the Mammotion logo. Below it are two input fields: 'E-mail' and 'Password'. The 'Password' field has a toggle icon for visibility. A large black 'Login' button is centered below the fields. Underneath the button are two links: 'Reset password' and 'Sign up'. A horizontal line separates this from the 'Other login methods' section, which features icons for Google and Apple. At the bottom, there is a green checkmark icon followed by the text 'Agree Privacy Agreement User Agreement'.

Input your email address and password, check **Privacy Agreement User Agreement**, then click **Login**.

NOTE

If you forget your password, click **Reset password** and follow the screen instructions to reset your password.

Log in with a third-party account

1. Click  or  (available for IOS user only) on the login page and you will be redirected to access the third-party authorization permission.
2. Select Associated account to link your Mammotion account if needed. Or,

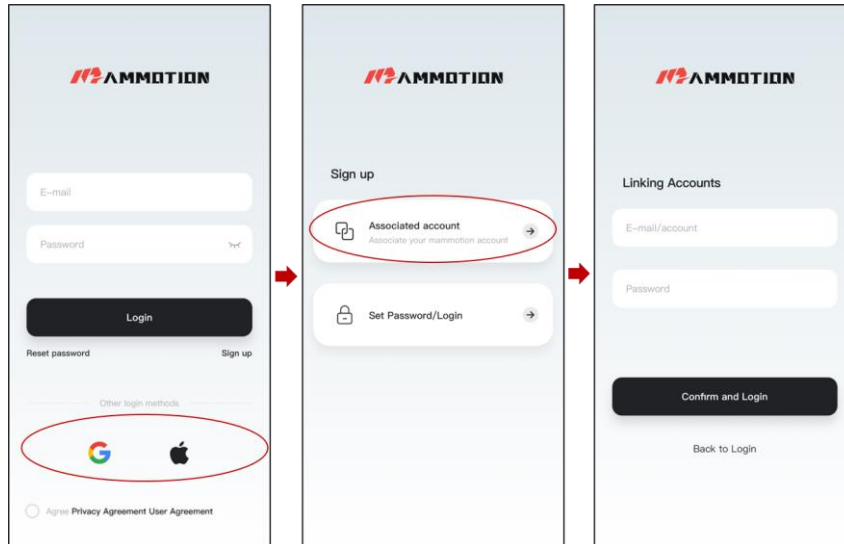

3. Click Set Password/Login to set your password for the Mammotion account you are signing up.

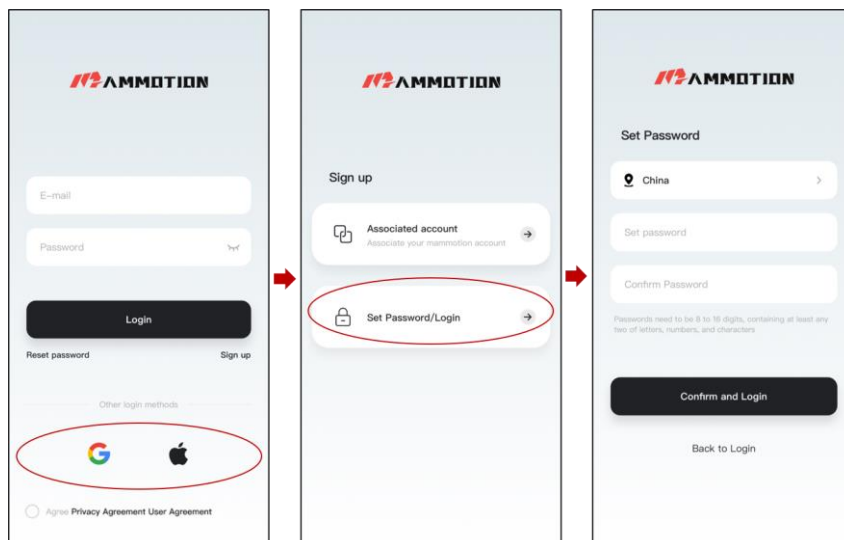

4. Click Confirm and login to log in.

4.4 Add Luba

NOTE

Make sure the distance between your phone and Luba is less than 3 m/10 ft.

1. Click + to add your Luba.
2. Select **Add Luba 2**.
3. Follow the onscreen guidelines to set up Luba.
4. Long press (5 s) the power button to turn on Luba.
5. Follow the onscreen instructions to connect Luba via Bluetooth and set network successfully.

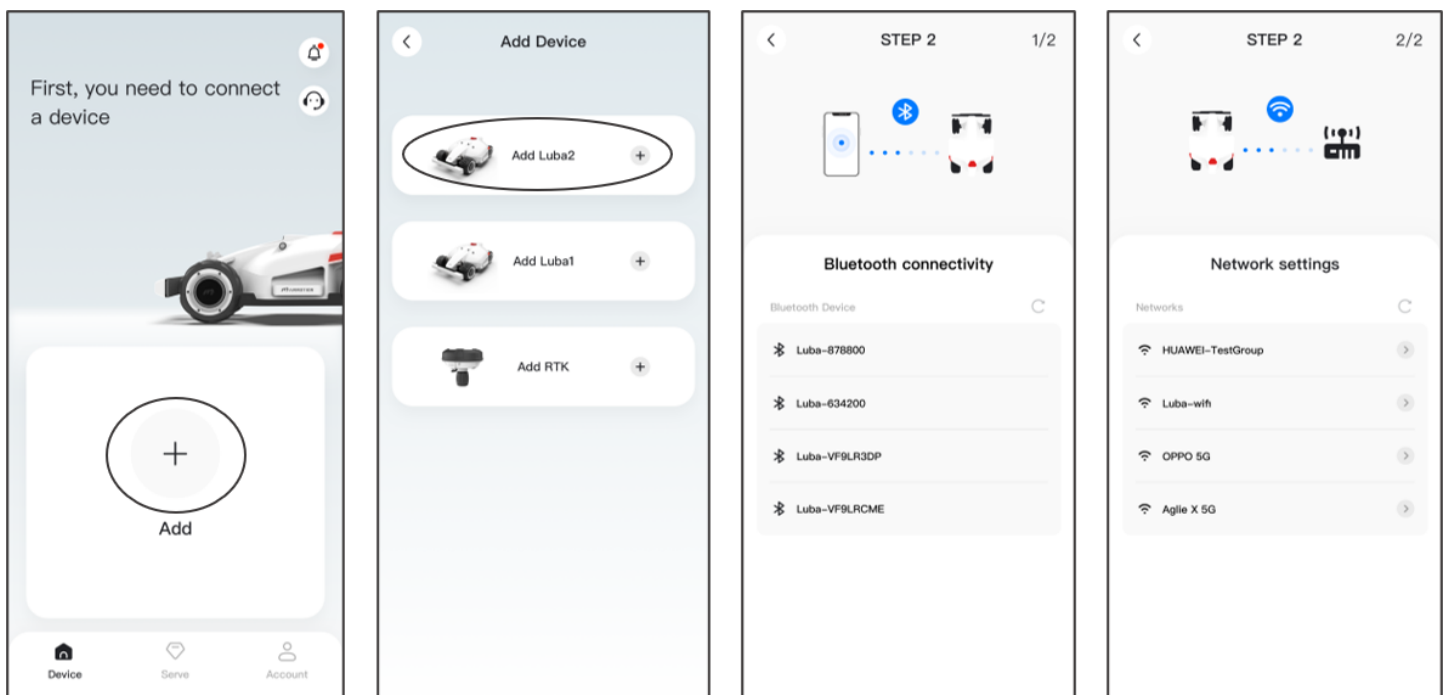

NOTE

The RTK reference station can also be added to check its data such as the number of satellites received, the log, etc. Click **Add RTK** to continue if needed.

4.5 Map Page Introduction

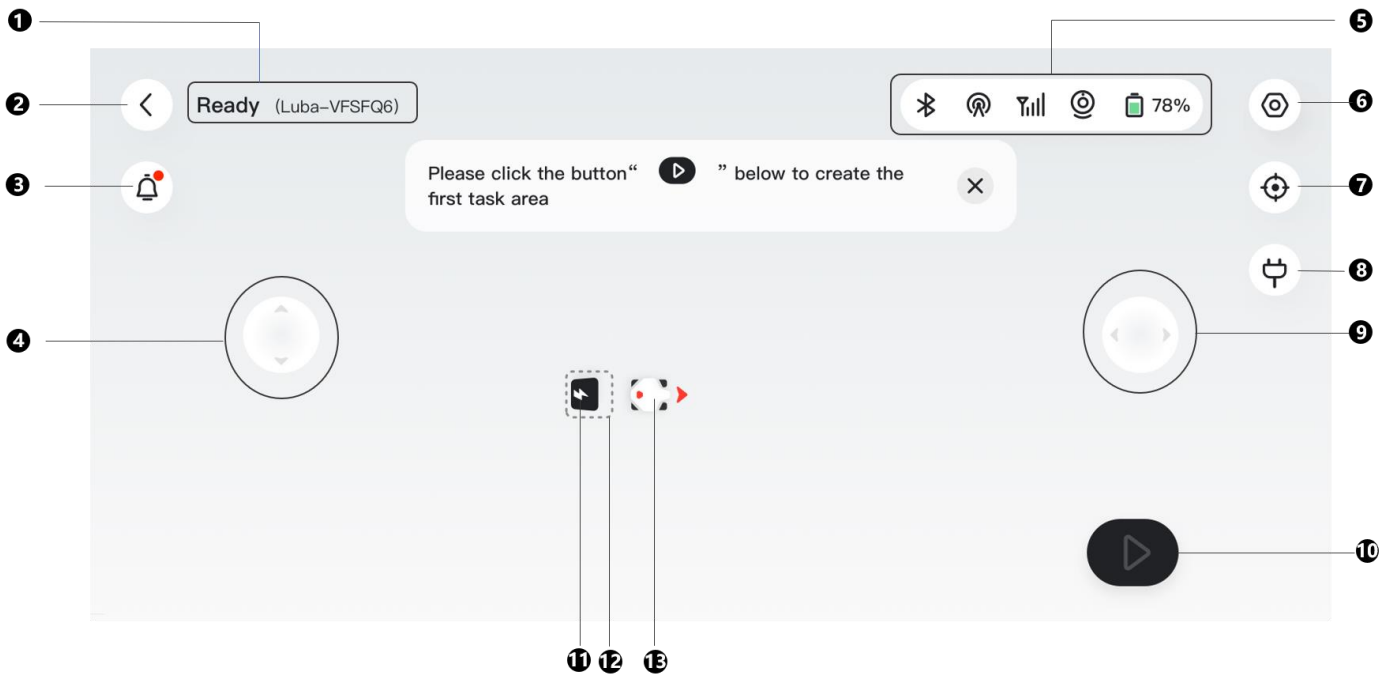

1. Luba status¹
2. Return to previous page
3. Notification²
4. Manually drive forward/backward
5. Status bar
6. Settings³
7. View returns to the center of the map
8. Auto recharge
9. Manually turn Luba clockwise or anti-clockwise
10. Click to start
11. Charging station
12. Charging area
13. Luba

NOTE

1. The Luba status will vary according to the actual conditions.
 2. See *Notification* for further information.
 3. See *Settings* for further information.
-

4.5.1 Create a Map

NOTE

The terms 'Map' and 'Task Area' in this context refer to the lawn.

Before mapping

Before mapping, it is important to be aware of key considerations.

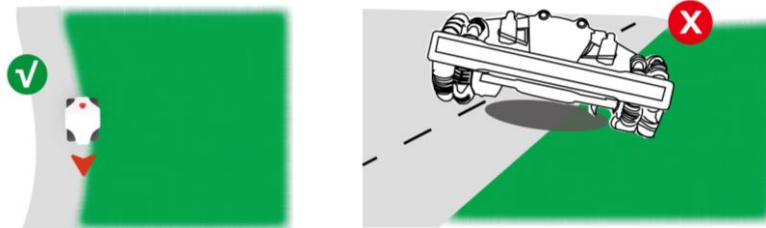

- Remove debris, piles of leaves, toys, wires, stones, and other obstacles from the lawn. Make sure no children or animals are on the lawn.
- Luba's status shows **Ready** and the positioning status is good.
- We highly recommend you leave 15 cm/6 in distance if you drive Luba along the edge of a wall/fence/obstacles/ditches.
- The controller should follow Luba within 3 m/10 ft to ensure a good Bluetooth connection and for safety reasons.
- Do not drive Luba on uneven curbs. However, for improved cutting, guide Luba along the lawn's boundary on the flat and open curb.

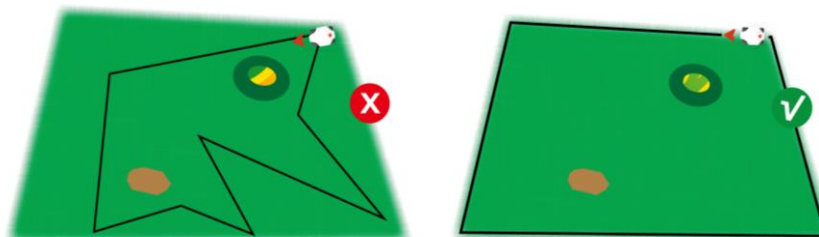

- Please mark the line along the edge of the lawn.



To map your lawn

1. Click the start button  on the Map page.
2. Manually control Luba to draw the boundary of your lawn. The solid line marks the boundary that you have set, while the dotted line will help you to get back to the starting point. The lawn map will not be created until you control Luba to the starting point.
3. Click  to adjust the boundary that has been set if needed. Guide Luba back along the path to the intended location.
4. Control Luba to the start point and click  to save the setting.

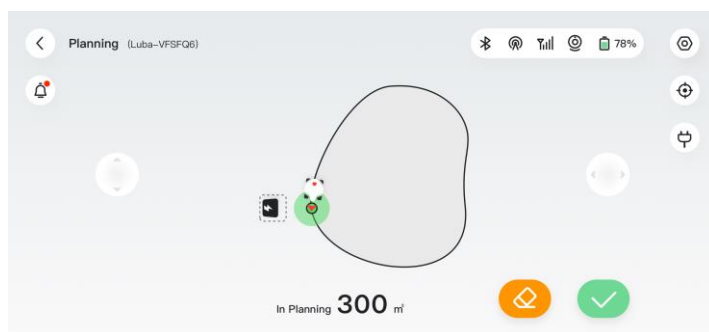
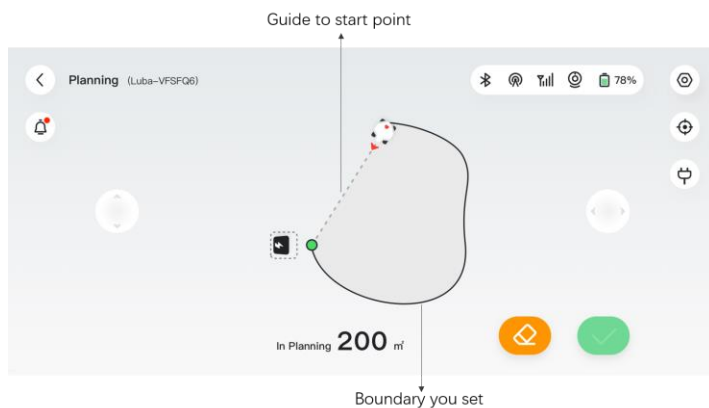

5. Select **Continue creating** in the pop-up then click **Channels** to add a connection path between your lawn and charging station.

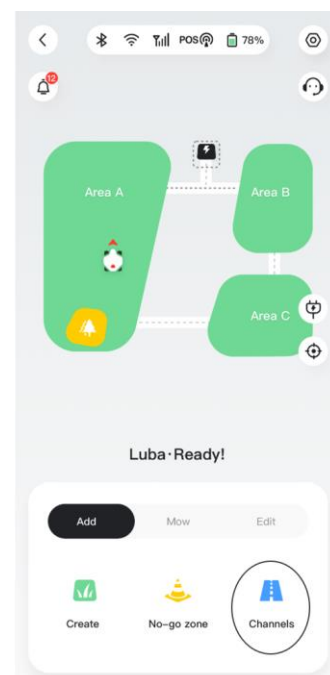
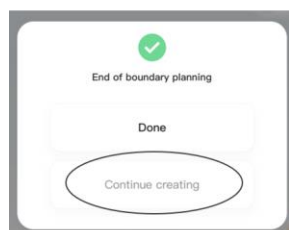

NOTE

- When mapping, the system will estimate the area. Please ensure that the area is not more than the upper limit (See *Technical Specifications* for more information), or the task planning will fail.
 - Drive Luba out of the task area or no-go zone first if a new task area is created.
-

To add a no-go zone

No-go zones are created for pools, flowerbeds, trees, roots, ditches, and any other obstructions present in the lawn. Luba will avoid mowing inside these designated areas.

- Click Add > No-go zone.

NOTE

- Ensure that Luba has been transported to the appropriate task location when creating a no-go zone.
 - No-go areas cannot be modified once they have been set.
-

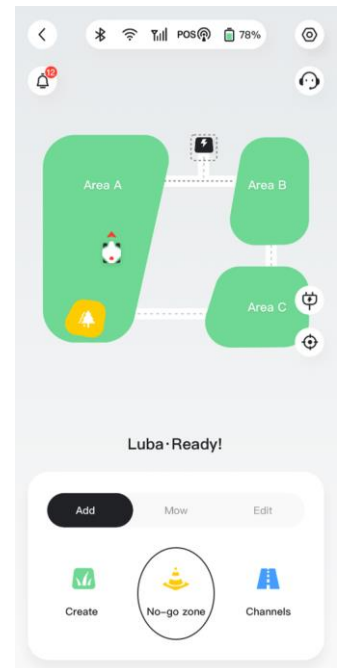

To add a channel

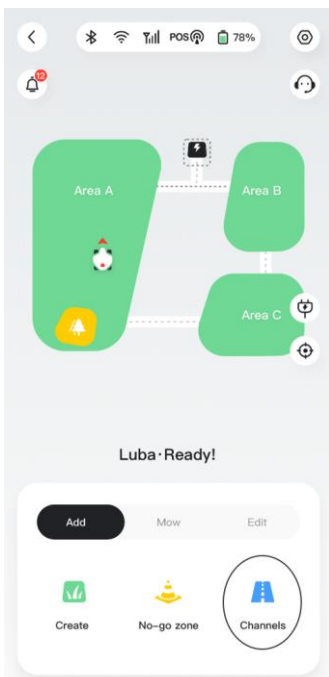

The channel is intended to connect various task areas or link the task area with charging station.

- Click Add > Channels

NOTE

- Channel cannot be modified once it has been set.
 - Ensure that Luba has been transported to the appropriate task location when adding a channel.
-

After mapping



1. Return to previous page
4. No-go zone
7. Settings
10. Auto-recharge

2. Notification
5. Control panel
8. Customer service

3. Task area
6. Status bar
9. Channel

11. View returns to the center of the map

To edit or delete the current task area

- To edit the current task area, click **Edit > Modify** to continue.
- To delete a task area, click **Edit > Delete** to continue.

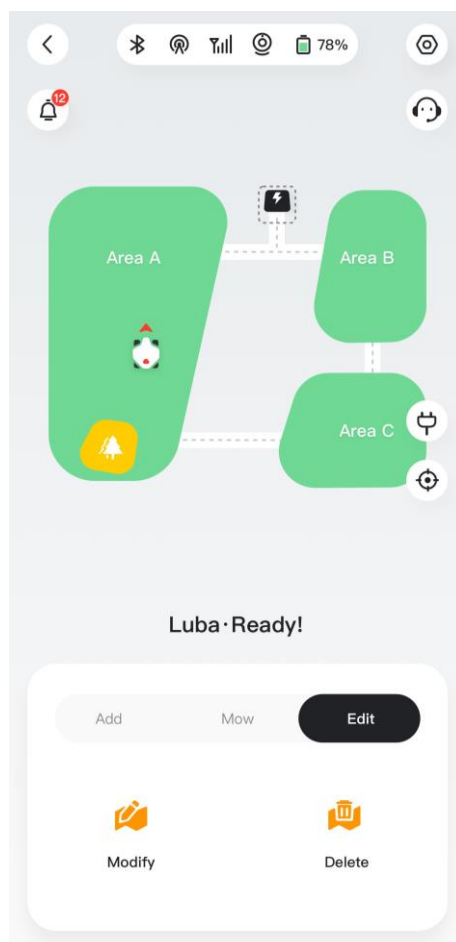

Multiple task areas with overlapping

If you have several lawns that overlap, the shared section will be assigned to the task area that was created first. No channel is necessary for two task areas with overlapping sections.

RTK reference station cannot move once your lawn mapping is finished

Do not move the RTK reference station after the map is created or the resulting cutting area will diverge from the designated task area. In the event of a RTK reference station relocation, please delete the current map and recreate.

4.5.2 Status Bar

From left to the right:

- Bluetooth
- Luba's Wi-Fi
- Cellular strength
- Positioning status
- Luba battery status
- Vision state and positioning status

Click the status bar to show the following details.

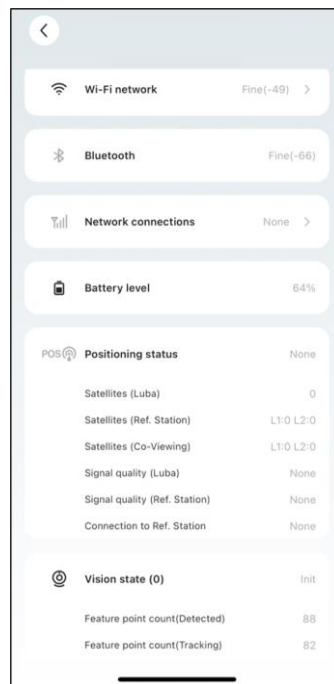

- Positioning status — shows the strength of positioning.
 - ✧ Fix — fine positioning status with an accuracy of less than 10 cm/4 in, up to 2 cm/1 in with a good open-sky area.
 - ✧ Float — poor positioning status with an accuracy about 50-200 cm/20-79 in.
 - ✧ Single — bad positioning status with a meter-level accuracy.
 - ✧ None — no positioning status.

*Only Fix status enables automatic mowing.

- **Satellites (Luba)** — refers to the total number of satellites received by Luba.
- **Satellites (Ref. Station)** — refers to the number of satellites that RTK reference station can receive. L1 and L2 respectively indicate the satellites operating at L1 and L2 frequencies.
- **Satellites (Co-Viewing)** — refers to the satellites received by both Luba and RTK reference station. Generally, having more than 20 L1 and L2 satellites with fine signal quality each is ideal for stable RTK positioning.
- **Signal quality (Luba)** — refers to satellite signal strength of Luba.
- **Signal quality (Ref. Station)** — refers to satellite signal strength of RTK reference station.

*The accuracy of positioning is affected by the quality of the satellite signal and the number of Co-Viewing satellites. Objects such as trees, leaves, walls, and fences can weaken the signal and lead to positioning errors. Despite detection of more than 20 satellites by both the Luba and RTK reference station, the signal quality can still be deemed as Weak or Bad.

- **Connection to Ref. Station** — refers to the connection status between the Luba and the RTK reference station.
 - ✧ **Weak or Bad** — indicates that the Luba is too far from the RTK reference station or that there are thick walls or buildings obstructing the signal.
 - ✧ **None** — indicates there is no connection between the RTK reference station and Luba. Without the data from the RTK reference station, RTK positioning cannot be accomplished. Please check whether the RTK reference station has been powered off or has any defects or whether the radio antenna has not been installed or the RTK pairing code is wrong (See [To reset/change the RTK pairing code](#) to correct the pairing code).

What to do when the Luba's positioning is not Fix.

- Satellite (Ref. Station): L1 < 20, L2 < 20
- Satellite (Co-viewing): L1 < 20, L2 < 20
- Positioning status: Float

Measures:

Place the RTK reference station in an area with unobstructed views of the sky, without any physical obstructions within at least 5 m/16 ft. Alternatively, position the RTK reference station on a wall or roof.

- Signal quality (Ref. Station): Bad or Weak
- Positioning status: Float

Measures:

Place the RTK reference station in an area with unobstructed views of the sky, without any physical obstructions within at least 5 m/16 ft. Alternatively, position the RTK reference station on a wall or roof.

- Satellite (Ref. Station): L1:0, L2:0
- Satellite (Co-viewing): L1:0; L2:0
- Positioning status: Single
- Connection to Ref. Station: None or Weak

Measures:

- ✓ Ensure the power supply to the RTK reference station is functioning normally.
- ✓ Verify that the indicator on the RTK reference station remains a constant green between the hours of 8:00-18:00 local time.
- ✓ Check for any defects within the RTK reference station, such as water leaks.
- ✓ Confirm that the radio antenna has been installed.
- ✓ Re-pair the RTK reference station and Luba to see if it can be fixed.
- ✓ If you replace the RTK reference station, pair the new station with Luba on the Mammotion app. For more details, visit <https://mammotion3006.zendesk.com/hc/en-us/articles/16503733641367>

- Satellite (Luba) < 25
- Satellite (Co-viewing): L1 < 20, L2 < 20
- Positioning status: Float

Measures:

Check if the area where the Luba is situated, particularly when the Luba is being charged, has tall trees/walls/metal barriers, etc.

- Signal quality (Luba): Bad or Weak
- Positioning status: Float

Measures:

- ✓ Check if Luba's current location is fully or partially covered.
- ✓ If the Luba is positioned on the charging station, relocate it to a less obstructed area.
- ✓ If the Luba is located on the perimeter/corner of the task area, adjust the boundary/corner to ensure it is not covered.
- ✓ If Luba is located within the task area and has lost its positioning due to obstacles such as trees, iron tables or chairs, mark those obstacles as no-go zones.

- Satellite (Luba): 0
- Satellite (Co-viewing): L1:0, L2:0
- Positioning status: None

Measures:

Check whether the Luba is inside or if its rear is covered with metal. If the Luba is faulty, please contact our after-sales team at https://mammotion3006.zendesk.com/hc/en-us/requests/new?ticket_form_id=13773144519703

- Satellite (Ref. Station): L1:0, L2:0
- Satellite (Co-viewing): L1:0; L2:0
- Positioning status: Float
- Signal quality (Ref. Station): None
- Connection to Ref. Station: None

Measures:

- ✓ Check if the RTK reference station has powered off.
- ✓ If the Luba is too far from the RTK reference station, narrow the distance between the RTK reference station and Luba and retry.
- ✓ Verify if there are any malfunctions with the antenna, RTK reference station, or Luba receiver. If so, please contact our after-sales team at https://mammotion3006.zendesk.com/hc/en-us/requests/new?ticket_form_id=13773144519703

4.5.3 Plan

With the Plan function, you can set a regular task and Luba will automatically do its work according to your setting.

To set a plan

NOTE

- The Plan function is disabled when Luba is in automatic mowing.
 - A plan can be set after a task map has been created.
-

1. Click **Plan** on the map page.
 2. Click + at the bottom start settings.
 3. Follow the onscreen information to set time, frequency, work area, cutting mode, and cutting height. Click **Start** to complete the setup. Or click **Preview** to preview the results if needed.
-

NOTE

For initial use of Luba, we strongly advise setting the cutting height to above 50 mm/2 in.

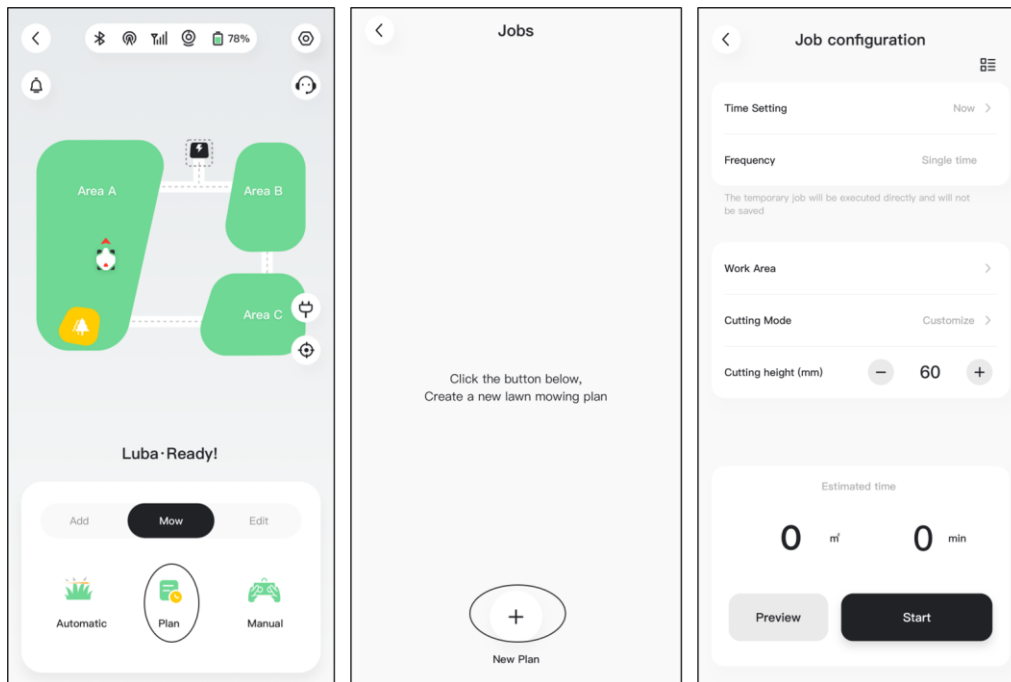

To change/delete a plan

1. Click **...** on the plan you set to open the drop-down menu.
2. Toggle the button to off to inactivate the plan if needed.
3. Click **Edit** to directly change the plan. Or
4. Select **Copy** to create a new plan with the same settings while keeping the original plan, then choose one to edit.
5. Click **Delete** to delete the plan.

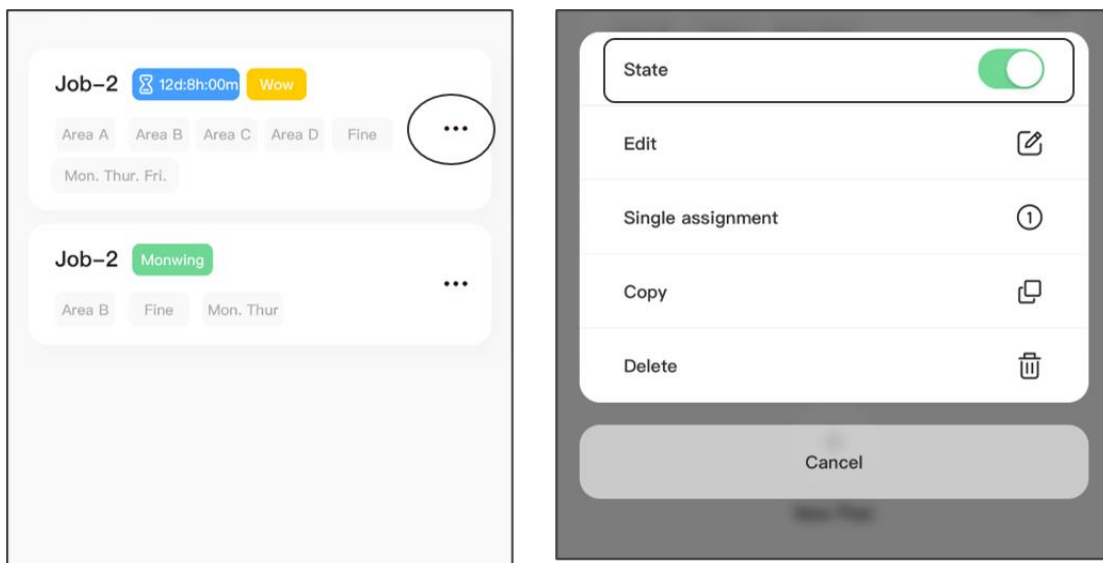

4.5.4 Customer Service

The Customer Service provides an internet-based chat service for any inquiries you may have and receive prompt responses from our technical support team. Simply click on **Chat to Agent** to start a conversation with one of our representatives.

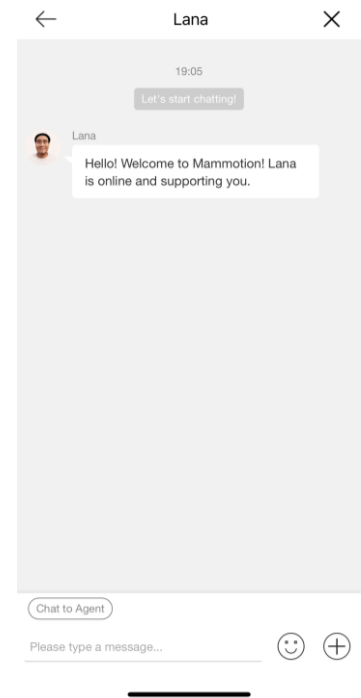

4.5.5 Mow

Preparation

- Ensure Luba is in the task area before mowing.
- If any unexpected problems arise, please press the **STOP** button and secure Luba. The button labelled STOP holds top priority among all commands.
- If the lift sensor is activated, Luba will come to a halt. Please press the **Grass** button followed by the **Start** button to activate Luba.
- Please mow the task area no more than once a day as doing so may be harmful to your lawn.
- If the grass height exceeds 60 mm/2 in, it is advisable to raise the cutting height to at least 40 mm/1.6 in. When mowing, it is important to only trim a third of the grass height each time. For example, if the initial grass height is 60 mm/2 in, the cutting height of Luba should be set to 40 or 45 mm/1.6 or 1.8 in. Similarly, if the grass is between 90-100 mm/3.5-4 in, the cutting height of Luba should be set to 60 mm/2 in.

To start mowing

1. Select **Mow** > **Automatic** to start mowing settings.
2. Choose one of the four available operation modes, which will be explained in the following sections.
3. Then follow the onscreen information to finish the settings and start mowing.

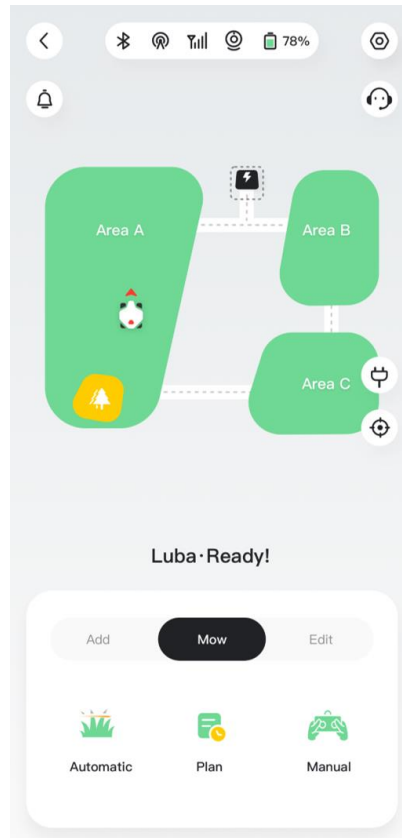

Operation modes

There are four operation modes to select:

- High grass
- Efficient cutting
- Fine cutting
- Customize

Table 4-1 Task Mode Description

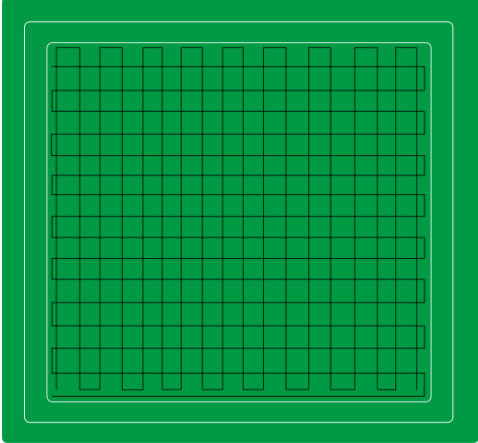
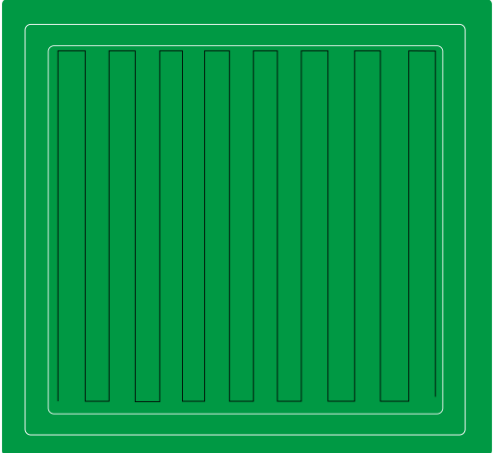
Mode	Description	Use Cases
<p>High grass</p>	<p>Only use the bumper to detect the obstacle, as too much tall grass can interfere with the ultrasonic sensor. Mowing path with double grid.</p> <p>Use Cases For lawns that have not been mowed for an extended period, the grass height typically exceeds 12 cm/4.7 in. The objective of cutting the grass is simply to bring its height down.</p>	
<p>Efficient cutting</p>	<p>Cut the grass at a higher speed than fine mode, using wider path spacing and a single grid mowing path. This may result in some grass being left uncut, particularly for thick and dense grass.</p> <p>Use Cases For typical domestic lawns, the cutting result may not be as refined for lawns with sturdy and dense grass. However, the efficiency is still greater than that of the Fine cutting mode.</p>	



Mode	Description	Use Cases
<p>Fine cutting</p>	<p>Cut at a lower speed (0.3 m/s) and reduce the spacing between each mowing pass using a double grid pattern.</p> <p>Use Cases</p> <p>For typical domestic lawns, cut the grass short but with reduced efficiency.</p>	
<p>Customize</p>	<p>Customer can define every task parameter. The parameters are explained in the <i>Table 4-2 Parameters Description</i>.</p> <p>Use Cases</p> <p>For more customized use.</p>	 or  etc.

Table 4-2 Parameters Description

Parameters	Description	Reference
Path spacing (cm)	The spacing between 2 mowing paths. Can be adjusted between 20 to 35.	
Task speed (m/s)	The speed of Luba when mowing. Lower speed produces better results for dense and thick grass at the cost of efficiency.	0.3-0.5
Obstacle detecting mode	Off: Bypass the obstacle at a fixed distance after the collision sensor is triggered.	
	Level 1: Bypass the obstacle at a dynamic distance after the collision is triggered.	
	Level 2: Avoid side obstacles before touching.	
Cutting route mode	Mowing path mode: No grid, single grid, double grid, and segment grid	
	No grid	Single grid
		

Parameters	Description	Reference
	<p>Double grid</p> 	<p>Segment grid</p> 
<p>Perimeter mowing laps</p>	<p>The mowing circles at the perimeter. *Under the No grid mode, the perimeter mowing laps cannot be set 0.</p>	
<p>No-go zone mowing laps</p>	<p>The grass-cutting circles surrounding the boundary of the restricted area.</p>	
<p>Border patrol first</p>	<p>Luba starts mowing from the boundary. *Available for single and double grid modes.</p>	
<p>Cutting route angle (°)</p>	<p>The direction of the cutting path can be changed. *Available for single and double grid modes.</p>	<p>E.g. set cutting route angle 30°</p> 
<p>Start progress</p>	<p>The starting point for mowing.</p>	<p>E.g. set 50% for start progress</p> 

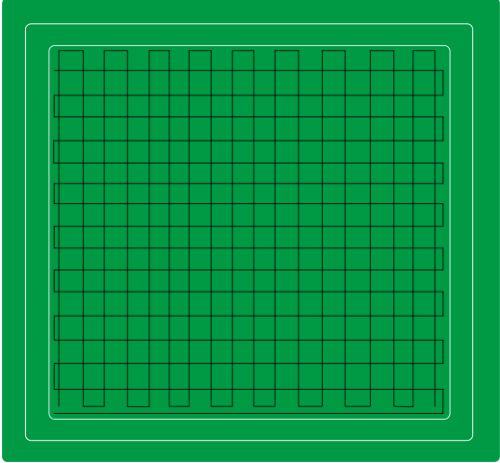
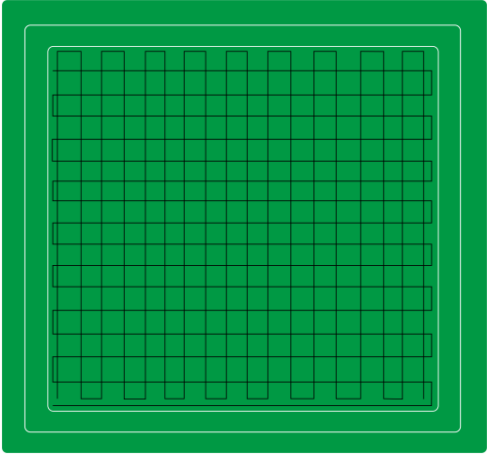
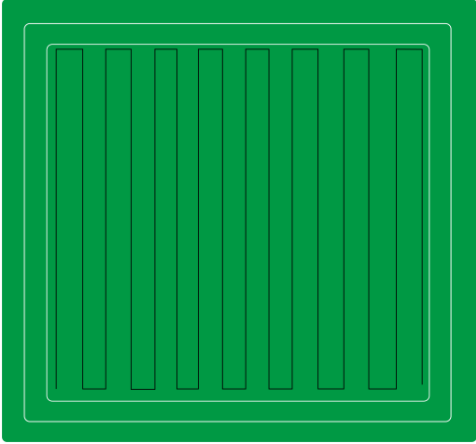
When Luba enters an area without RTK signals while mowing

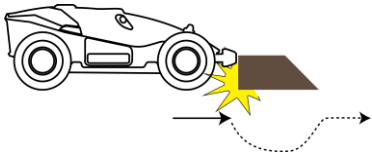
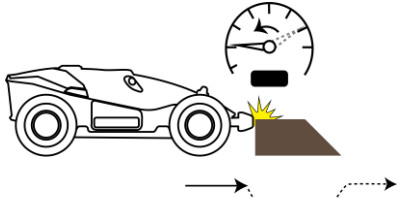
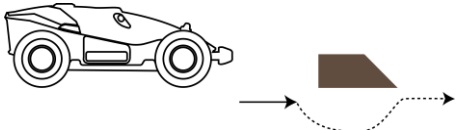
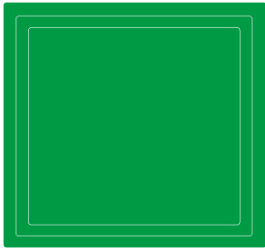
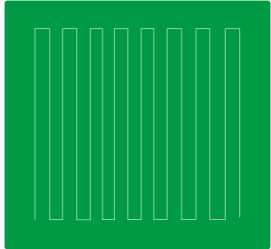
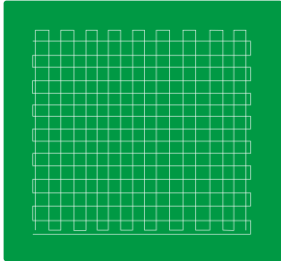
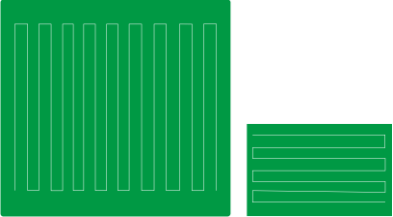
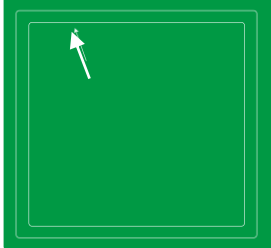
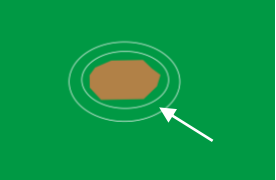
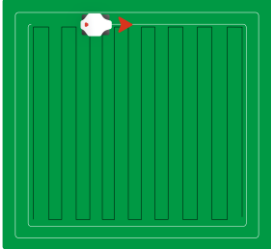
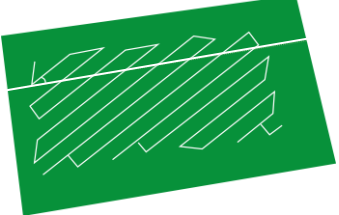
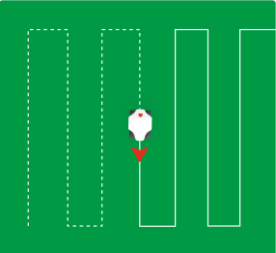
If Luba enters an area without RTK signals while mowing, the multi-sensor fusion positioning system will assist Luba in continuing to operate through the vision module. The app will display the remaining momentum. Luba should return to an area covered by RTK signals before the momentum reaches 0, otherwise, Luba will come to a stop.

4.5.6 Manual mowing

To ensure your safety, please use the **Manual mowing** function with care and observe the following:

- Persons under the age of 18 are not permitted to use this function;
- Please always supervise your children, pets and important belongings to prevent accidents;
- Take extra care when using the manual lawn mower function to avoid injury.

Manual mowing page introduction

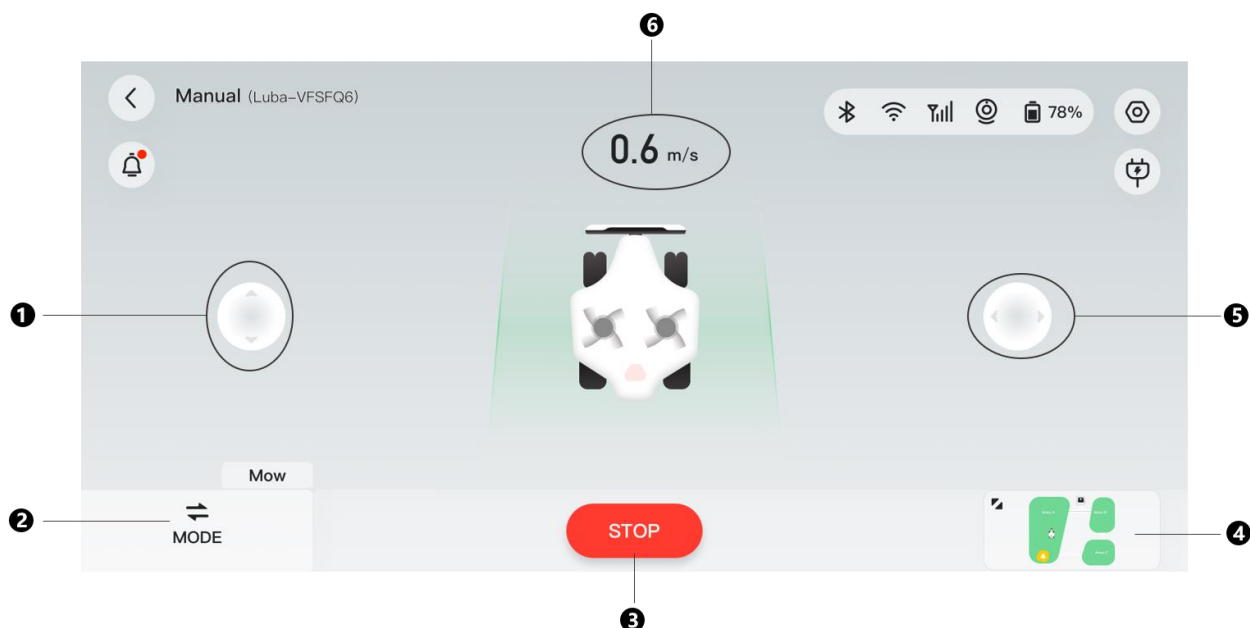

1. Manually drive forward/backward
2. Switch mode
3. Start/Stop mowing
4. Switch to Video mode
5. Manually turn Luba clockwise or anti-clockwise
6. Mowing speed

To activate Manual mowing

1. On the Map page, select **Mow** > **Manual**.
2. Click **Start**, then drag to the right to start the cutting disk.
3. Maneuver forwards/backwards or turn left/right to start working.

NOTE

- The cutting disk will automatically stop after 5 seconds of inactivity.
 - Drag to the right as prompted by the app to start the cutting disk after each stop.
 - Click  to switch the interface.
-

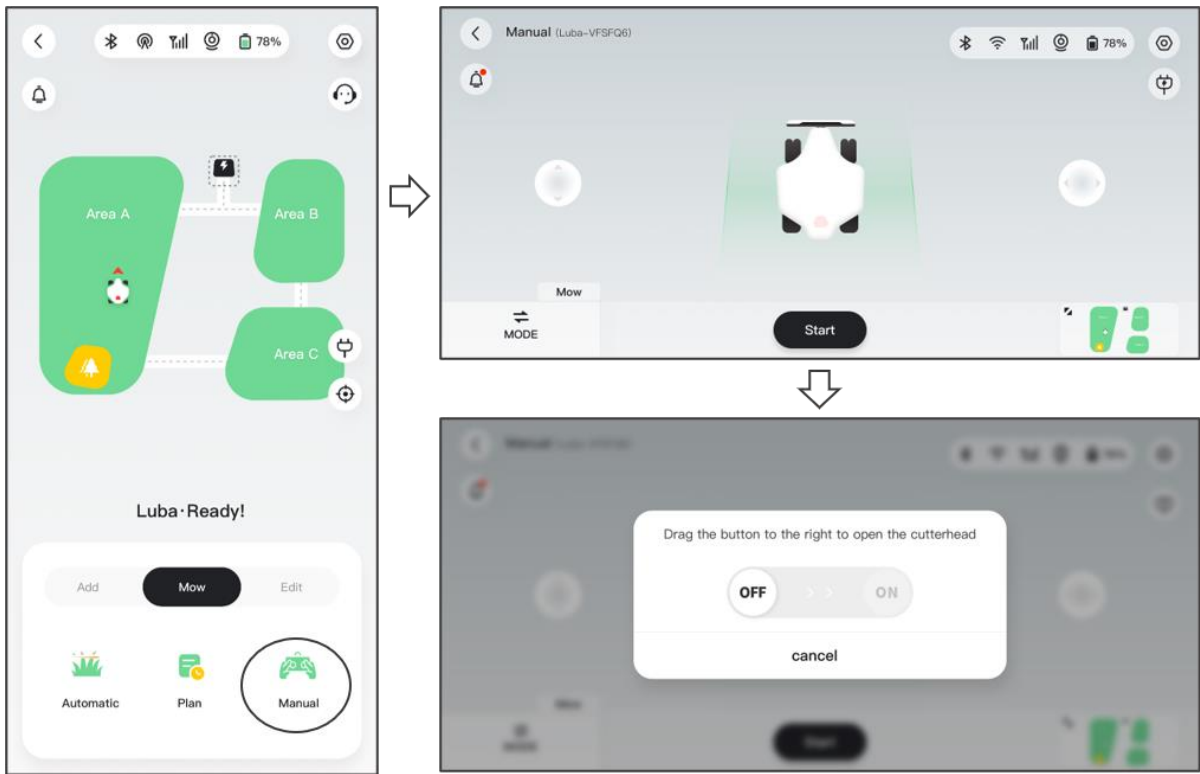

Mode switch

Click on **MODE** on the lower-right corner to switch between Manual and Video interfaces to clearly locate your Luba.



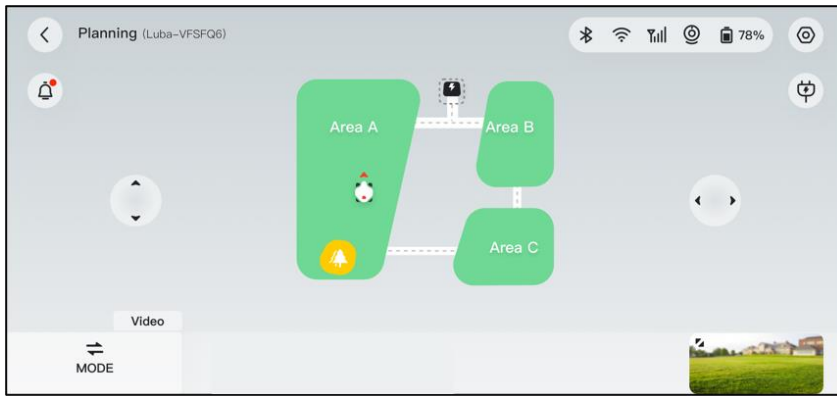

4.5.7 Track your devices

In the case that your Luba or RTK reference station is missing, go to **Device** page to track your equipment.

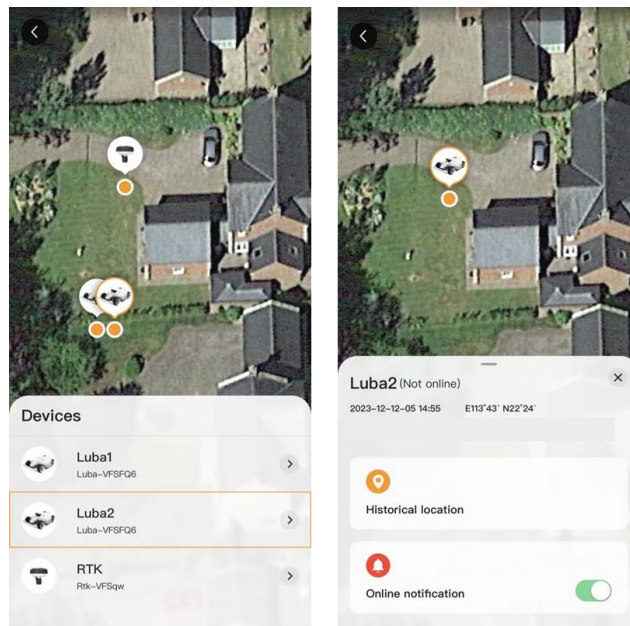

4.5.8 Notification

Information regarding the status, any errors, etc. will be displayed in the notification section. Click the push notification for more details.

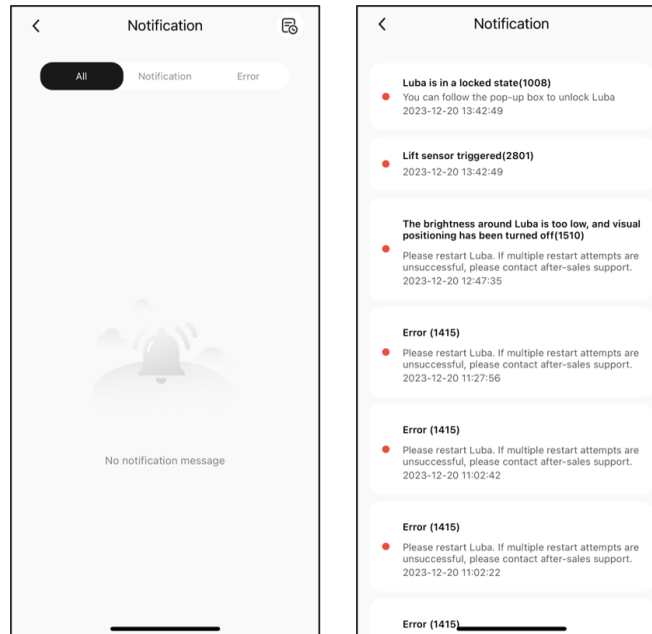

4.5.9 Settings

There are two modules in the settings:

- Device — click each item to access more operations.
- Settings — includes Mow setting and App settings. Mow settings will be explained further in the following sections.

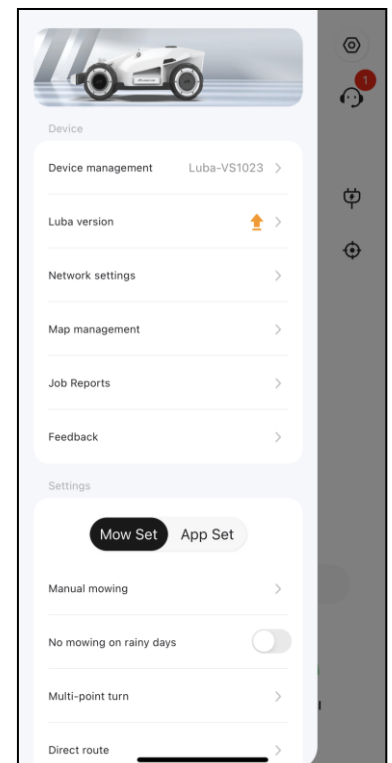

- **Mow settings**

- ✧ Manual mowing — Click to enter manual mowing mode. See [Manual mowing](#) for details.
- ✧ No mowing on rainy days — when you enable this function, the Luba will not mow if it rains.
- ✧ Multi-point turn — Luba turnaround mode. Multi-point turn is selected by default as it is more turf friendly.

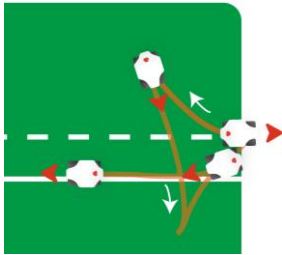

- ✧ Zero turn — Luba turnaround mode. Zero turn is typically designed for a channel that requires turns.

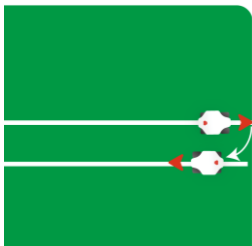

- ✧ Side light — click to turn on/off the side indicator of the Luba.
- ✧ Delete map — click to delete the task area you create.
- ✧ Recharge route — provides two ways to recharge: **Direct route** or **Follow the boundary**; **Direct route** means that the Luba takes the shortest route to return to the charging station; **Follow the boundary** means that the Luba drives down the border to the charging station without leaving any tracks on the lawn.

Direct route

Follow the boundary



- ✧ RTK pairing code — you can select to reset or change the RTK pairing code. See [To reset/change the RTK pairing code](#) for additional information.
- ✧ Relocate charging station — click to relocate the charging station. See [To reset/change the RTK pairing code](#)

The first RTK pairing code is read from the Luba. To link a different RTK reference station, access **Settings**, go to **RTK pairing code**, select **Change**, then enter the LoRa number found on the RTK reference station sticker and click **Confirm** to update it. Clicking and confirming the **Reset** button will delete the current pairing code, so be sure to back it up before proceeding.

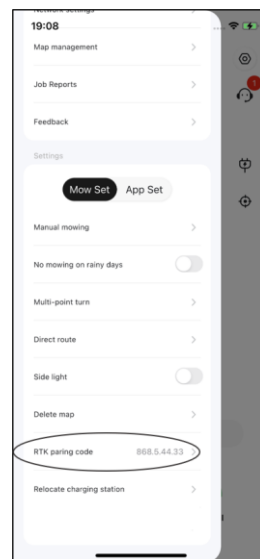

- ✧ **To relocate the charging station** for additional information.

To reset/change the RTK pairing code

The first RTK pairing code is read from the Luba. To link a different RTK reference station, access **Settings**, go to **RTK pairing code**, select **Change**, then enter the LoRa number found on the RTK reference station sticker and click **Confirm** to update it. Clicking and confirming the **Reset** button will delete the current pairing code, so be sure to back it up before proceeding.

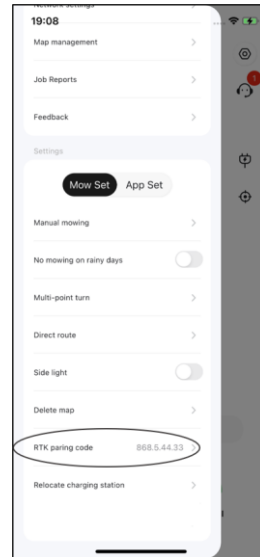

To relocate the charging station

NOTE

Please relocate the charging station while Luba is charging.

Generally, the charging station should be relocated if

- The charging station and RTK reference station are moved.
 - The docking path has a significant incline.
 - The docking process is consistently off track.
1. Install the RTK reference station/charging station in a proper place.
 2. Place Luba on the charging station and ensure the positioning status is fine.
 3. Select **Settings > Relocate charging station**.
 4. Any existing task areas and schedules will be deleted as the entire system will be changed.

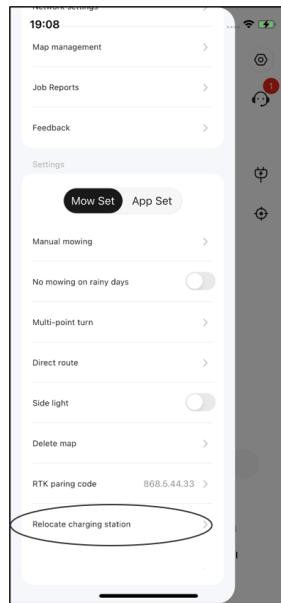

4.5.10 Auto-recharge

NOTE

When performing auto-recharge function, Luba must be in the task area.

Auto-recharge allows Luba to automatically return to charge when the battery is lower than 15%.

To perform auto-recharge

- Click  on the map page in Mammotion app, or
- Press the button  on the Luba, then press  to guide Luba to the charging station.

5 Product Specifications

5.1 Technical Specifications

Table 5-1 Standard Version Specifications

Standard Version (Cutting Height: 30-70 mm/1.2-2.7 inches)				
Specifications	LUBA 2 AWD			
	10000	5000	3000	1000
Max. Mowing Size	10,000 m ² / 2.5 acres	5,000 m ² / 1.25 acres	3,000 m ² / 0.75 acres	1,000 m ² / 0.25 acres
In-App Area Storage Capacity	12,000 m ² / 3 acres	6,000 m ² / 1.5 acres	3,500 m ² / 0.9 acres	1,200 m ² / 0.3 acres
Max. multi-zone Management	60	30	20	10
Engine	All-wheel Drive (AWD)			
Max. Climbing Ability	80% (38.6°)			
Max. Slope at the Edge	45% (24°)			
Vertical Obstacle Passing Ability	50 mm/2 in.			
Cutting Width	40 cm/15.7 in.			
In-App Cutting Height Adjustment	30-70 mm/1.2-2.7 in.			
Charging Time	150 min			90 min
Mowing Time per Charge	180 min			120 min
Auto-recharge	YES			

Positioning & Navigation	3D Vision & RTK	
Obstacle Avoidance	3D Vision & Ultrasonic Radar & Physical Bumper	
Voice Control	Alexa & Google Home	
Vision Monitoring	YES	
Connectivity	4G & Bluetooth & Wi-Fi	
Noise Level	60 dB	
A weighted sound power	L _{WA} =64dB, K _{WA} =3dB	
A weighted sound pressure	L _{PA} =56dB, K _{PA} =3dB	
Waterproof	LUBA Machine: IPX6 Charging Station: IPX6 RTK Station: IPX7	
Rain Detection	YES	
Weight	17.65 kg/38.9 lbs.	17.12 kg/37.7 lbs.
Size (L x W x H)	69 x 51 x 27 cm/27.2 x 20.2 x 10.7 in.	

Table 5-2 H Version Specifications

H Version (Cutting Height: 60-100 mm/2.4-4 inches)				
Specifications	LUBA 2 AWD			
	10000H	5000H	3000H	1000H
Max. Mowing Size	10,000 m ² / 2.5 acres	5,000 m ² / 1.25 acres	3,000 m ² / 0.75 acres	1,000 m ² / 0.25 acres
In-App Area Storage Capacity	12,000 m ² / 3 acres	6,000 m ² / 1.5 acres	3,500 m ² / 0.9 acres	1,200 m ² / 0.3 acres
Max. multi-zone Management	60	30	20	10
Engine	All-wheel Drive (AWD)			
Max. Climbing Ability	80% (38.6°)			
Max. Slope at the Edge	45% (24°)			
Vertical Obstacle Passing Ability	80 mm/3.1 in.			

H Version (Cutting Height: 60-100 mm/2.4-4 inches)		
Cutting Width	40 cm/15.7 in.	
In-App Cutting Height Adjustment	60-100 mm/2.4-4 in.	
Charging Time	150 min	90 min
Mowing Time per Charge	180 min	120 min
Auto-recharge	YES	
Positioning & Navigation	3D Vision & RTK	
Obstacle Avoidance	3D Vision & Ultrasonic Radar & Physical Bumper	
Voice Control	Alexa & Google Home	
Vision Monitoring	YES	
Connectivity	4G & Bluetooth & Wi-Fi	
Noise Level	60 dB	
A weighted sound power	$L_{WA}=66\text{dB}$, $K_{WA}=3\text{dB}$	
A weighted sound pressure	$L_{PA}=58\text{dB}$, $K_{PA}=3\text{dB}$	
Waterproof	LUBA Machine: IPX6 Charging Station: IPX6 RTK Station: IPX7	
Rain Detection	YES	
Weight	18 kg/39.8 lbs.	17.5 kg/38.6 lbs.
Size (L x W x H)	70 x 51 x 30 cm/27.2 x 20.2 x 12 in.	

Table 5-3 Battery Specifications

Parameters	Specifications
Battery charger	GQ180-250700-E4 Input: 100-240V~, 50/60Hz, 2.5A Output: 25.2VDC, 7.0A, 176.4W
Battery pack	Battery pack for 10000, 5000, 3000, 10000H, 5000H, and 3000H: 21.6Vdc, 9.6Ah Battery pack for 1000 and 1000H: 21.6Vdc, 4.5Ah
Temperature range for charging is 4-45 °C / 39-113 °F.	
WARNING: For the purposes of recharging the battery, only use the detachable supply unit provided with this appliance.	

5.2 LED Indicator Codes

Table 5-4 Luba's Indicator Description

Indicator	Status	Description
Side Indicator	Red	<ul style="list-style-type: none"> ● System initialization ● Manual control mode ● Automatic work mode ● Charging finished (Luba still on the charging station)
	Breathing red	OTA upgrade in progress
	Slow flash red	<ul style="list-style-type: none"> ● RTK positioning failed ● Emergency stop activated ● Charging in progress
	Fast flash red	<ul style="list-style-type: none"> ● Low battery ● Luba powering off
	Very fast flash red	<ul style="list-style-type: none"> ● System upgrade failed ● OTA upgrade failed
	Off	<ul style="list-style-type: none"> ● Pause ● Standby ● Sleeping
Front Indicator	Green	Power on
	Off	Power off
Vision Module Indicator	Green	RTK positioning is working well.
	Flash green	The RTK positioning has failed, but the vision positioning is working well.
	Red	Both RTK and vision positioning have failed.
	Flash blue	Luba's firmware is being upgrading.
	Blue	Luba powered on successfully.

Table 5-5 Charging Station's Indicator Description

Indicator	Status	Description
Charging station indicator	Flash green	Luba is being charging.
	Green	Luba is fully charged or uncharged.
	Red	An error has occurred.

Table 5-6 RTK Reference Station Indicator Description

Indicator	Status	Description
RTK reference station indicator	Flash blue	The reference station is powering on.
	Flash green	The reference station is initializing.
	Green	The initialization is finished.
	Off	The initialization is finished and the local time is between 18:00 and 8:00.
	Red	An error has occurred.

5.3 Fault Codes

The app notification displays common fault codes along with their causes and troubleshooting steps. Here lists the most common issues.

Fault Codes	Causes	Solutions
316	The left cutting disk motor is overheating.	The machine will return to normal once the motor has cooled down. This process may take several minutes.
318	The sensor for the left cutting disk motor has failed.	Restart Luba. If the issue persists after a few times of restart, contact the after-sale team.
323	The right cutting disk motor is overloaded.	Check if the cutting disk is jammed and clear it if necessary. Alternatively, raise the cutting height.
325	The right cutting disk motor fails to start.	Check whether the cutting disk is jammed. If not, restart Luba. If the issue persists after a few times of restart, contact the after-sale team.
326	The right cutting disk motor is overheating.	Restart Luba. If the issue persists after a few times of restart, contact the after-sale team.
328	The sensor for the right cutting disk motor has failed.	Restart Luba. If the issue persists after a few times of restart, contact the after-sale team.
1005	Low battery	Luba will continue working after the battery is charged to 80%.
1300	The positioning status is poor.	Await Luba's repositioning.

Fault Codes	Causes	Solutions
1301	The charging station has been moved.	Relocate the charging station.
1420	Timeout occurred while retrieving wheel speed data.	Restart Luba. If the issue persists, contact the after-sale team.
2713	Charging has been stopped due to low battery voltage.	Restart Luba. If the issue persists after a few times of restart, contact the after-sale team.
2726	The battery is overcharged.	Stop charging immediately. If overcharging occurs frequently, contact the after-sale team.
2727	The battery is over discharged.	Recharge Luba.

6 Warranty

Mammotion Technology Co., Ltd warrants that this product will be free from material and workmanship defects under normal use in accordance with the product materials published by Mammotion during the warranty period. The published product materials include but not limited to user manual, quick start guide, maintenance, specifications, disclaimer, in-app notifications, etc. The warranty period varies among different products and parts. Check the table below:

Component	Warranty
Main Body	2 Years
Battery	2 Years
Charging Station & RTK Antenna	1 Year
Tire	No warranty
Decoration/Appearance	No warranty
Cutting blade	No warranty

NOTE

Tire, decoration/appearance, and cutting blade are wearing parts, which are excluded from warranty.

If the product does not function as warranted during the warranty period, please contact Mammotion customer service for instructions. Please provide receipt and product' s serial number when contacting customer service.

- The warranty period for the product starts from the day when the product is delivered.
- If you cannot provide an invoice or other valid proof of purchase, then the warranty period will begin 90 days after the production date shown on the product, unless otherwise agreed

upon between you and Mammotion.

- Mammotion will need users to arrange the shipment by themselves if users would like to send the products to local service center or Mammotion factory for further diagnosis. Mammotion will repair or replace and send back to users at no cost if the problem falls under the warranty. If not, Mammotion or designated service center may charge a fee accordingly.
- Mammotion guarantees that, subject to the following conditions, Warranty Repair Service can be requested. Please contact Mammotion or your authorized Mammotion dealer for more details. You will be required to fill out a repair form or RMA (Return Material Approval), which should be sent to us along with the to-be-repaired unit.
- DOA (dead-on-arrival, defective-on-arrival, and/or damaged-on-arrival), refers to goods that are defective on arrival. After receiving goods from Mammotion, or the authorized dealer, if the product appears to be damaged or has performance failure(s), please contact Mammotion or your authorized Mammotion dealer to identify and confirm if a replacement is needed.
- Replacement applies to DOA cases. It should be requested within 7 calendar days of receiving the goods. The replacement will be completed within 30 calendar days upon receipt of the completed goods, including all original accessories, attachments and packaging.
- RMA (Return Material Approval), please fill out the form provided by Mammotion, scan, and email to support@mammotion.com.

Here puts some examples of faults that warranty will not cover:

All the damages caused by misuse or not following the user manual and below:

1. Third party claims against you for damages
2. Loss, damage or disclosure of your data
3. Special, incidental, punitive, indirect or consequential damages, including but not limited to lost profits, business revenue, goodwill or anticipated savings. In no case should the

total liability of Mammotion, its affiliates, suppliers, resellers, or service providers for damages from any cause exceed the amount of actual direct damages, not to exceed the amount paid for the product.

7 Compliance

EC/EU DECLARATION OF CONFIRMITY

Manufacturer: Mammotion Technology Co., Limited

Address: UNIT 89 3/F YAU LEE CENTRE NO.45 HOI YUEN ROAD, KWUN TONG KL

Authorised Representative: Bowen International GmbH

Address: Jagdfeldring 72,85540, Haar (Germany)

The name and address of person authorized to compile the technical file: Bowen International GmbH, Jagdfeldring 72, 85540, Haar (Germany).

Herewith declares that the Machinery:

Generic Designation: Robotic Lawnmower

Product Name: LUBA 2 AWD

Type / Model(s): 1000, 3000, 5000, 10000, 1000H, 3000H, 5000H, 10000H

Described as: Robotic Lawnmower for Grass Cutting

Cutting Width: 400mm Power: 97.2Wh / 207.36Wh

Complies with the following Directives,

2006/42/EC

2014/53/EU

ROHS 2.0

Standards conform to,

EN 60335-1:2012+A11:2014+A13:2017+A1:2019+A2:2019+A14:2019+A15:2021,

EN 50636-2-107:2015+A1:2018+A2:2020+A3:2021

Article 3.1a:

EN IEC 62311:2020

EN IEC 62368-1:2020+A11:2020

Article 3.1b:

EN IEC 61000-6-1:2019

EN IEC 61000-6-3:2021

EN 61000-3-3: 2013+

A1:2019+A2:2021

EN IEC 61000-3-2:

2019+A1:2021

EN 301 489-1 V2.2.3

EN 301 489-3 V2.3.2

EN 301 489-17 V3.2.4

EN 301 489-19 V2.2.1

EN 301 489-52 V1.2.1

Article 3.2:

EN 300 220-1 V3.1.1

EN 300 220-2 V3.2.1

EN 300 328 V2.2.2

EN 303 413 V1.2.1

EN 301 893 V2.1.1

EN 300 440 V2.2.1

EN 301 511 V12.5.1

EN 301 908-1 V15.2.1

EN 301 908-2 V13.1.1

EN 301 908-13 V13.2.1

IEC 62321-3-1:2013

IEC 62321-5:2013

IEC 62321-4:2013+A1:2017

IEC 62321-7-1:2015

IEC 62321-7-2:2017

IEC 62321-6:2015

IEC 62321-8:2017

ISO 18219:2015

Signed for and on behalf of: Mammotion Technology Co., Limited

Signed: Roland Huang

Name: Roland Huang

Date: 29/11/2023

Position: Product manager

Place: Shenzhen, China





MAMMOTION TECHNOLOGY CO., LTD

UNIT 89 3/F YAU LEE CENTRE NO. 45 HOI YUEN ROAD, KWUN TONG KL

www.mammotion.com

Copyright © 2023, MAMMOTION All Rights Reserved.